

CATALOG

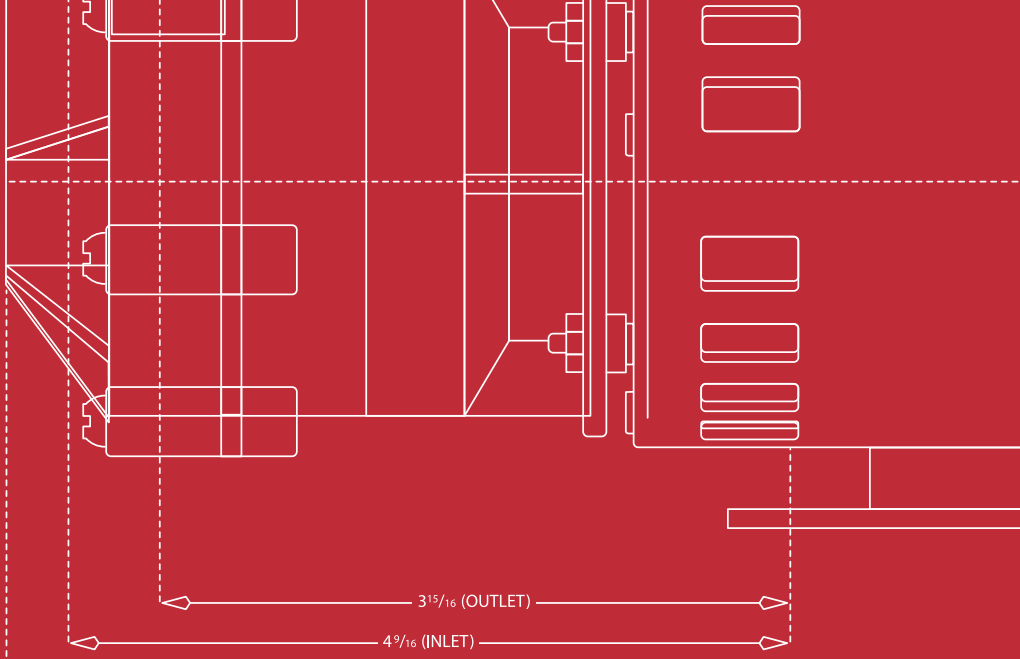

# MARCH PUMPS

CHEMICAL • OEM • INDUSTRIAL • HYDRONIC • SOLAR

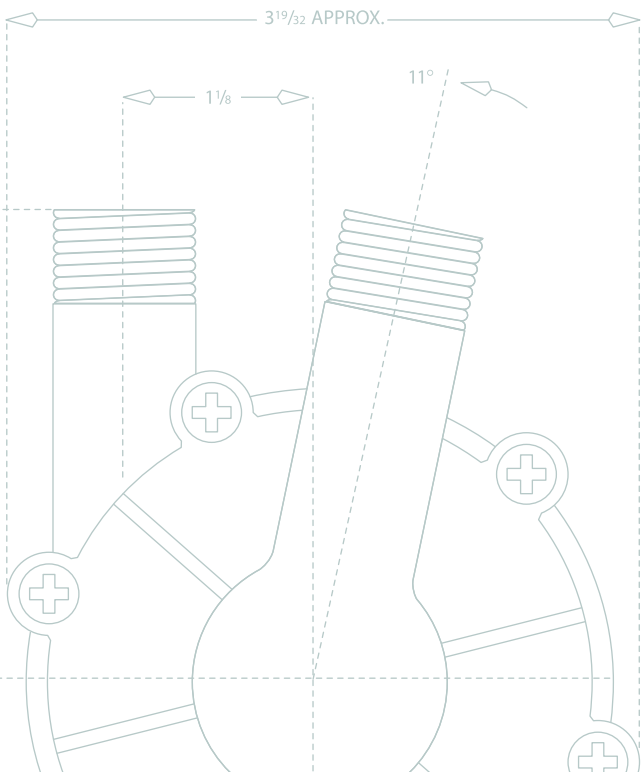

SEAL-LESS MAGNETIC DRIVE PUMPS

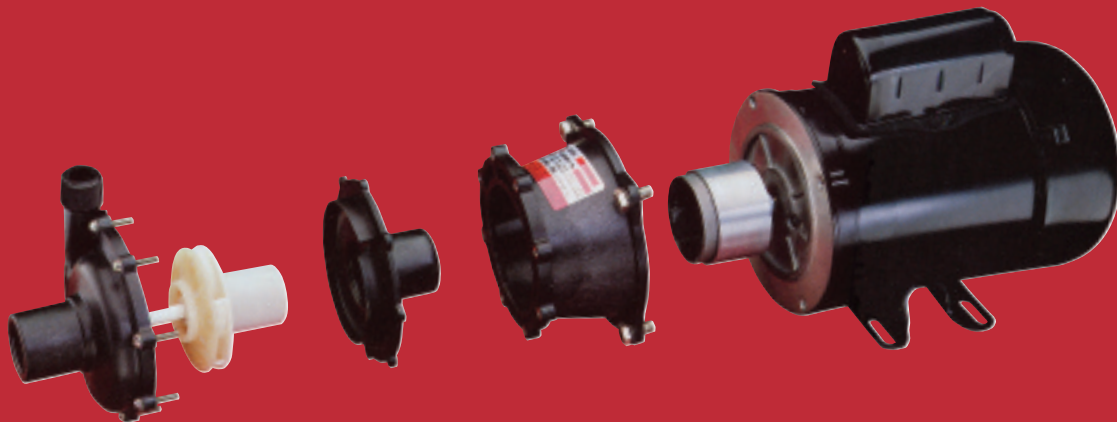

# MARCH SEAL-LESS MAGNETIC DRIVE PUMPS

The ultimate in reliable performance for chemical, OEM, industrial, hydronic and solar applications.



March specializes in a wide range of precise, highly reliable magnetic drive centrifugal pumps. March pumps are designed for virtually any application, from aquariums and icemakers, to chemical and processing equipment, to one-of-a-kind special applications such as the United States space shuttle program. These include pumps for handling a virtually unlimited array of fluids from water to highly corrosive or acidic solutions, as well as high

temperature liquids. Various designs range from air-cooled to fully submersible electric-powered unit motors to air motor-driven models for certain environments.

Whether it's a special pump design for an OEM application, or for a unique industrial process, March is your source for reliable, efficient solutions to difficult pumping problems. For worldwide availability and unparalleled service, contact March.

## No shaft, no seals, no seal problems.

Introduced in 1963, March's patented magnetically coupled drive designs eliminate shaft seals and the many problems they can cause. Torque is transmitted by a magnetic field from the magnet attached to the motor, through the solid body, to the magnet attached to the impeller. Benefits of magnetically coupled pumps include:

- **Leak-proof** No maintenance associated with seal wear.
- **Efficient** Friction-free operation reduces power consumption. Full motor horsepower is transferred to pumping power with no power loss.
- **Built-in overload protection** The magnetic coupling acts as a clutch to provide overload protection and prevent motor burnouts under heavy loads from high specific gravity liquids.

See Pump Directory on page 35



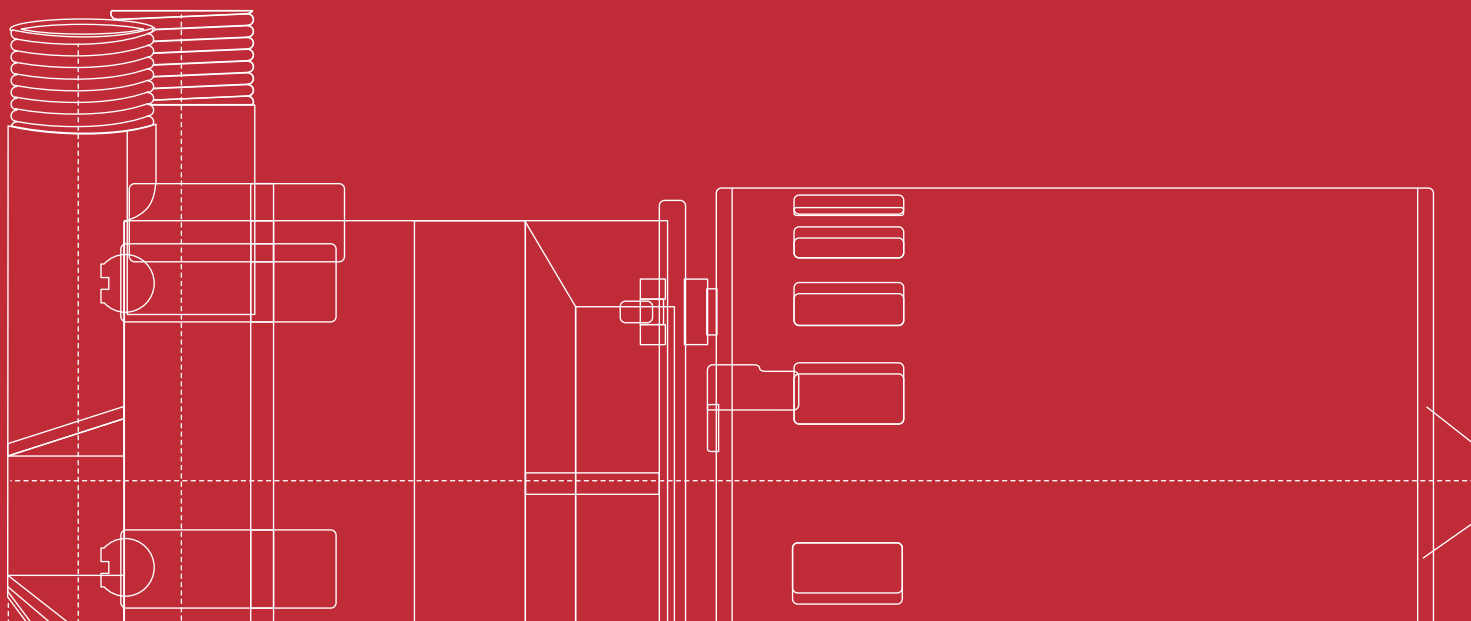

- **Easily maintained** Many models are designed so that the motor can be removed from the pump housing, inspected and replaced without draining the system. No special tools or training are required.
- **Reliable** Magnetic drive pumps offer trouble-free performance over many years of service life.

### High-performance designs.

All pump parts are designed to meet or exceed potential job demands. In pumps intended for use with highly corrosive fluids, all components to be exposed to the liquid (often referred to as “wetted materials”) are either encapsulated or molded of appropriately resistant plastics. Metals are used where plastics are incompatible with the solution to be handled. Proven materials such as polypropylene, Ryton®, polyvinylidene fluoride resin (PVDF or Kynar®), stainless steel and Hastelloy® cover a broad range of applications. UL-recognized components are used throughout, and many models are UL-listed.

March also specializes in custom designs for unique applications. Contact a March engineer for a pump with the performance and materials required for your special project. Chances are there’s a March pump that’s right for you...if not, we’ll build it!

### Internal component sourcing for enhanced quality control.

The breadth and depth of March’s product scope is unmatched. In addition to pumps, our manufactured products include some fractional horsepower motors and all injection-molded plastic components.

This unrivaled level of “in-house” component manufacturing capability not only results in designs with the ideal combination of serviceable features and optimized performance, it also forms an effective, start-to-finish quality control umbrella for the entire finished product with no compromise in quality, reliability and durability.

### Wide selection of motors for different applications.

Most March pumps utilize fan-cooled motors for long life under continuous operating conditions. Blast-cooled, totally enclosed, submersible, drip-proof and ball bearing motors are also available with various models, depending on the intended use. Many models are available with air motors, particularly recommended for use in explosive environments. All motors are UL listed.



### Fast, easy access to products and service.

A full stock of pumps, parts and technical support is available worldwide from more than 150 stocking sales and service locations.

The March line includes more than 200 standard pumps with capacities from 3 gpm on 60hz (9 LPM on 50 hz) to 210 gpm on 60 hz (680 LPM on 50 hz). The flow, head and electrical data listed in metric LPM, meters, bars etc. are based on 50 hz operation. All other data is based on 60 hz operation.

### Material Selection Guidelines

**Chemical Compatibility** Care must be exercised in selecting the proper materials for pump components that will be exposed to the fluid being handled. Nitric, chromic, hydrochloric and sulfuric acids as well as benzene, alcohol, freon, kerosene and other solvents are some of the more common highly corrosive chemicals that March pumps are designed to withstand. In all cases, consult a March engineer regarding materials for various chemicals and solution concentrations.

### Specifications

All performance specifications and test data shown in this catalog are based on pumping water and are intended as guidelines only. Specifications will vary depending on specific fluid, temperatures and other operating conditions.

### Warranty

March pumps are guaranteed against defects in materials or workmanship for one year from the date of manufacture. Warranty will be extended for up to one year from the date of purchase, provided that the warranty card is returned to the factory within 10 days of the purchase date. In all events, liability is limited to the purchase price and to the replacement or repair of any pump or parts defective in

materials or workmanship. All pumps for which a warranty claim is made must be returned to the factory with shipping costs prepaid. This warranty is void if the pump has been subjected to misuse or negligence.

This warranty applies only to pumps used to pump water. For applications with all other solutions, contact the factory for verification of warranty terms before the pump is installed.

### Model Nomenclature

Because components and materials of construction vary widely and are unique to each model, model nomenclature is not standardized. The following are some typical abbreviations used in model numbers:

In some cases, letter portions of the nomenclature are a designation of the material that will come in contact with the solution that is to be pumped, such as bushings and “O” rings. For example, a “K” indicates Kynar® PVDF and “S” signifies a metallic pump head and impeller magnet assembly made of 316 stainless steel. A “C” in the model number indicates that the pump wet end is made of glass filled polypropylene, and the impeller assembly and bushing material are made of polypropylene. Both the spindle and the front thrust washer are of high grade ceramic. The standard “O” ring for this model is made of Viton®.

*For complete flow curves and dimensional assembly drawings, visit our Web Site - [www.marchpump.com](http://www.marchpump.com).*

### MOTOR-TYPE ABBREVIATIONS

AC	air cooled
AM	air motor
BC	blast cooled
BB	ball bearing
DP	drip proof
SUB	submersible (blue epoxy color)
TEFC	totally enclosed/fan cooled
TE/SUB	totally enclosed/submersible (maroon color = can run in open air or submerged)

As with all MARCH pumps, the latter two letters of the model number (MD) indicate that the pump is magnetically coupled to the motor.





model AC-1A-MD



model 1U-MD



model 1A-MD

# SERIES 1

## 1.7 to 3.0 gpm

Small but versatile, March Series 1 pumps can deliver a minimum of 1.7 GPM (7 LPM) up to 3.0 GPM (9 LPM). All Series 1 pumps are capable of serving applications with a maximum head of 4.5 ft. (1.3 m). at zero GPM (0 LPM). Applications include photographic processing equipment, refrigeration systems and water displays or fountains. Maximum recommended fluid temperatures are 190° F (87° C) for open-air models, or 130° F (55° C) for submersible models.

Series 1 pumps are available in both open-air and epoxy clad submersible models with a variety of options in both materials of construction and inlet and discharge ports. Options for wetted materials include polypropylene, Noryl®, nylon, Buna N rubber and 316 stainless steel. Most models feature ceramic magnets and Chemloy® washers.

Series 1 pumps are supplied with 1/4" MPT, 3/8" (9.5mm) O.D. 1/2" (12.7mm) O.D. or screened inlets and 1/4" MPT, 3/8" (9.5mm) O.D. or 1/2" (12.7mm) O.D. outlets. A bulkhead style inlet is available on request. Pumps with 1/2" (12.7mm) O.D. or 1/4" MPT inlet and outlet will flow 3.0 GPM (9 LPM) maximum at zero ft. head, while pumps with 3/8" (9.5mm) O.D. inlet and outlet will flow 1.7 GPM (7 LPM) maximum at zero ft.

Series 1 pumps use 1/200 HP (.003 kw), 3200 rpm, 115-volt or 230-volt single phase, 50/60 Hz., air-cooled or epoxy encapsulated submersible motors (maroon in color), suitable for both open-air or submersible duty.



model 1A-MD  
with stainless steel base

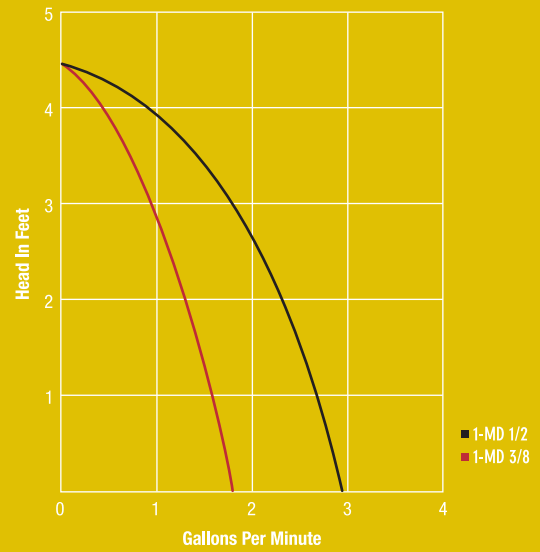

Flow curves may vary depending on the current motors being used.  
Contact your local distributor for accurate current data for layout purposes.

ELECTRIC MOTORS

SERIES 1		AC-1A-MD	AC-1C-MD	1A-MD-3/8	1A-MD 1/2	1C-MD	1U-MD
max. flow	gpm	3.0	3.0	1.7	3.0	3.0	3.0
	lpm	9	9	7	9	9	9
max. head	ft.	4.6	4.6	4.6	4.6	4.6	4.6
	m	1	1	1	1	1	1
inlet		1/2" OD	1/4" MPT	3/8" OD	1/2" OD	1/4" MPT	Screen
outlet		1/2" OD	1/4" MPT	3/8" OD	1/2" OD	1/4" MPT	1/4" MPT
hp		1/200	1/200	1/200	1/200	1/200	1/200
kw		.003	.003	.003	.003	.003	.003
rpm <sup>Ⓞ</sup>		3200	3200	3200	3200	3200	3200
volts <sup>Ⓞ</sup>		115	115	115	115	115	115
ph		1	1	1	1	1	1
hz		50/60	50/60	50/60	50/60	50/60	50/60
watts		19	19	19	19	19	19
amp		.45	.45	.45	.45	.45	.45
motor type		AC	AC	TE/SUB	TE/SUB	TE/SUB	SUB
electrical connection		16" (40cm) loose leads	16" (40cm) loose leads	6 ft. (1.8m) SJT w/plug	6 ft. (1.8m) SJT w/plug	6 ft. (1.8m) SJT w/plug	6 ft. (1.8m) SJT w/plug
max. int. pressure	psi	50	50	50	50	50	50
	bar	3.4	3.4	3.4	3.4	3.4	3.4
max. liquid temp.	°f	190	190	190 open air, 160 sub	190 open air, 160 sub	190 open air, 160 sub	190 open air, 160 sub
	°c	87	87	87 open air, 71 sub	87 open air, 71 sub	87 open air, 71 sub	87 open air, 71 sub
weight packed	lbs.	2.3	2.3	2.5	2.5	2.5	2.5
	kg.	1.04	1.04	1.13	1.13	1.13	1.13
materials in contact with solution <sup>Ⓞ</sup>		polypropylene, nylon, Buna N, .316 stainless steel, ceramic magnet, Chemloy <sup>®</sup> washer.		Same when pump is used in open air, when submerged, the Epoxy, Noryl <sup>®</sup> , and SJT cord are also in contact with the solution.			

- Ⓞ Other materials and voltages available on special order.
- Ⓞ RPM at wide open flow and 0 head, RPM increases as head is increased.





model 893-03



model 893-04



model 893-07

# SERIES 893

## 2.7 to 3.0 gpm

Designed to operate at 12 or 24 volts DC, March Series 893 pumps are small in physical size and can deliver a maximum of up to 3.0 GPM (11 LPM) and can develop pressures up to 4.5 PSI (.31 BARS). All Series 1 pumps are capable of serving applications with a maximum head of 10.5 ft. (3.3m) at zero GPM.

They are manufactured in both open-air and fully submersible versions. Applications include photographic processing equipment, refrigeration systems and water displays or fountains. Maximum recommended fluid temperatures are 190° F (87° C) for open-air models, or 160° F (71° C) for submersible models. Options for wetted materials include Noryl®, Delrin®, nylon, Buna N rubber, 316 stainless steel. All models feature ceramic magnets and Chemloy® washers. Other materials are available on special order.

Series 893 pumps are supplied with 3/8" FPT inlets and 3/8" (9.52mm) O.D. smooth outlets. Other size inlets and outlets for hose and threaded connections are available on special order. A bulkhead style inlet is available on request.

Series 893-03 pumps thru 893-06 feature brush type motors, rated at 3000 hours. They use 1/150 HP (.004kw), 4000 rpm, 12- or 24-volt DC, air-cooled or encapsulated submersible motors. For easy identification, submersible motors are blue in color. Models 893-07 thru 893-10 feature highly reliable brushless motors rated at a 50,000-hour service life. The 12-volt brushless motor will operate between 7 & 14 volts and draws 1.0 amp max at wide-open flow when pumping water. The 24-volt brushless motor will operate between 12 to 28 volts.





model 893-09

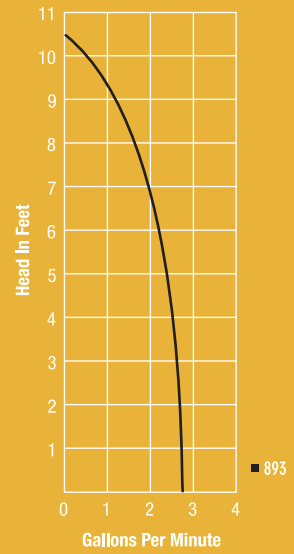

ELECTRIC MOTORS

SERIES 893		893-03	893-04	893-05	893-06	893-07	893-08	893-09	893-10
		max. flow	gpm lpm	2.7 11	2.7 11	2.7 11	2.7 11	2.7 11	2.7 11
max. head	ft. m	10.6 3.3	10.6 3.3	10.6 3.3	10.6 3.3	10.6 3.3	10.6 3.3	10.6 3.3	10.6 3.3
inlet		3/8" FPT	3/8" FPT	3/8" FPT	3/8" FPT	3/8" FPT	3/8" FPT	3/8" FPT	3/8" FPT
outlet		3/8" OD	3/8" OD	3/8" OD	3/8" OD	3/8" OD	3/8" OD	3/8" OD	3/8" OD
hp		1/150	1/150	1/150	1/150	1/150	1/150	1/150	1/150
kw		.004	.004	.004	.004	.004	.004	.004	.004
rpm <sup>Ⓢ</sup>		4000	4000	4000	4000	4000	4000	4000	4000
volts <sup>Ⓢ</sup>		12	12	24	24	12	24	12	24
ph		DC	DC	DC	DC	DC	DC	DC	DC
watts		12	12	12	12	12	12	12	12
amp		1.0	1.0	.5	.5	1.0	.5	1.0	.5
motor type		AC	SUB	AC	SUB	AC	AC	SUB	SUB
electrical connection		Terminals	18" (45.5 cm) loose leads	Terminals	18" (45.5 cm) loose leads	18" (45.5 cm) loose leads	18" (45.5 cm) loose leads	18" (45.5 cm) loose leads	18" (45.5 cm) loose leads
max. int. pressure	psi bar	50 3.4	50 3.4	50 3.4	50 3.4	50 3.4	50 3.4	50 3.4	50 3.4
max. liquid temp.	°F °C	190 87	190 open air, 160 sub 87 open air, 71 sub	190 87	190 open air, 160 sub 87 open air, 71 sub	190 87	190 87	190 open air, 130 sub 87 open air, 55 sub	190 open air, 130 sub 87 open air, 55 sub
weight packed	lbs. kg.	1.0 .45	1.2 .54	1.0 .45	1.2 .54	1.0 .45	1.0 .45	1.2 .54	1.2 .54
materials in contact with solution <sup>Ⓢ</sup>		Noryl <sup>®</sup> , Nylon, Buna N, 316 Stainless Steel, Ceramic magnet, Chemloy washer, plus Epoxy & PVC wire on the sub pump.							

Ⓢ Other materials and voltages available on special order.  
 Ⓢ RPM at wide open flow and 0 head, RPM increases as head is increased.



model MDXT



model MDX-3 1/2



model MDX-MT3

# SERIES MDX

## 5.5 to 8.4 gpm

Series MDX pumps can deliver a maximum flow of 8.4 GPM (38 LPM), are capable of serving applications with a maximum head of 19 ft. (4m) (26 ft. [9m] when driven by an air motor). Applications include coffee dispensers, aquariums, bio-medical, dryers, ice makers, electrostatic painting, photographic processing, and vending equipment.

Options for wetted materials include glass filled polypropylene, Ryton®, Kynar®, 316 stainless steel, and Buna N rubber for total chemical compatibility. Most models feature ceramic magnets and shafts and Viton® “O” rings.

Series MDX pumps are offered with a variety of inlet and outlet port types and sizes as shown. Contact the factory for other sizes and types of inlets and outlets.

Series MDX pumps use 1/50 HP (.014 kw) (1700 rpm) to 1/15 HP (.049 kw) (3450 rpm), 115- or 115/230-volt single phase, 50/60 Hz., air-cooled motors. Air motors rated at 1/8 HP (.093 kw) are also available for certain environments.

Explosion proof motors available on TE-MDX-MT3 and TE-MDK-MT3.

AIR MOTORS

SERIES MDX		MDX-3 1/2-AM	MDX-3 5/8-AM	MDXT-3-AM	MDX-MT3-AM	MDK-MT3-AM
max. flow	gpm	7.8	7.8	7.8	8.6	8.6
	lpm	37	37	37	38	38
max. head	ft.	26	26	26	26	26
	m	9	9	9	9	9
inlet		1/2" OD	5/8" OD	1/2" FPT	1/2" MPT	1/2" MPT
outlet		1/2" OD	5/8" OD	3/8" FPT	1/2" MPT	1/2" MPT
hp		1/8	1/8	1/8	1/8	1/8
kw		.093	.093	.093	.093	.093
rpm ©		2600	2600	2600	2600	2600
max. air pressure	psi	21	21	21	21	21
	bar	1.4	1.4	1.4	1.4	1.4
max. CFM req'd		3	3	3	3	3
motor type		AM	AM	AM	AM	AM
max. int. pressure	psi	50	50	50	75	75
	bar	3.4	3.4	3.4	5	5
max. liquid temp.	°f	190	190	190	200	200
	°c	87	87	87	93	93
weight packed	lbs.	4	4	4	4	4
	kg.	1.8	1.8	1.8	1.8	1.8
materials in contact with solution ©		Glass filled polypropylene, Buna N, Ceramic magnet			Ryton, Ceramic, Viton®	Kynar, Ceramic, Viton®

© Other materials available on special order.

© RPM at wide open flow and 0 head, RPM increases as head is increased.





model MDXT-3-AM



model TE-MDX-MT3

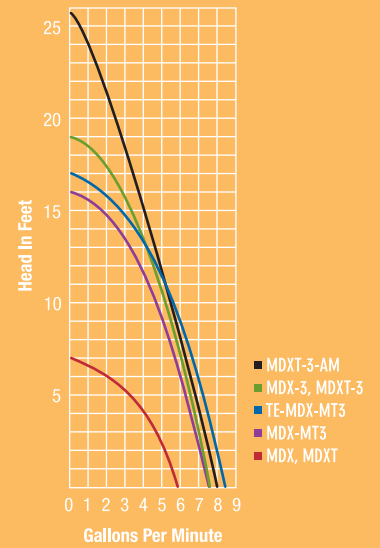

ELECTRIC MOTORS

SERIES MDX		MDX-1/2	MDX-5/8	MDXT	MDXT-3	MDX-3 1/2	MDX-3 5/8	MDX-MT3	TE-MDX-MT3	TE-MDK-MT3
max. flow	gpm	5.5	6.0	6.0	7.6	7.6	7.6	7.6	8.4	8.4
	lpm	22	22	22	30	30	30	30	35	35
max. head	ft.	7	7	7	19	19	19	16	17	17
	m	1.6	1.6	1.6	4	4	4	3.5	3.7	3.7
inlet		1/2" OD	5/8" OD	1/2" FPT	1/2" FPT	1/2" OD	5/8" OD	1/2" MPT	1/2" MPT	1/2" MPT
outlet		1/2" OD	5/8" OD	3/8" FPT	3/8" FPT	1/2" OD	5/8" OD	1/2" MPT	1/2" MPT	1/2" MPT
hp		1/50	1/50	1/50	1/25	1/25	1/25	1/25	1/15	1/15
kw		.014	.014	.014	.029	.029	.029	.029	.049	.049
rpm <sup>Ⓢ</sup>	us	1700	1700	1700	3400	3400	3400	3400	3450	3450
	metric	1400	1400	1400	2600	2600	2600	2600	2875	2875
volts <sup>Ⓢ</sup>	us	115	115	115	115	115	115	115	115/230	115/230
	metric	230	230	230	230	230	230	230	115/230	115/230
ph		1	1	1	1	1	1	1	1	1
hz	us	60	60	60	50/60	50/60	50/60	50/60	50/60	50/60
	metric	50	50	50	50/60	50/60	50/60	50/60	50/60	50/60
watts	us	64	64	64	108	108	108	110	130	130
	metric	63	63	63	113	113	113	108	95	95
amp	us	.85	.85	.85	1.35	1.35	1.35	1.35	.86/.43	.86/.43
	metric	.43	.43	.43	.73	.73	.73	.68	.50	.50
motor type		AC	AC	AC	AC	AC	AC	AC	TEFC	TEFC
electrical connection		3 ft. (.9M) SJT Cord	3 ft. (.9M) SJT Cord	3 ft. (.9M) SJT Cord	3 ft. (.9M) SJT Cord	3 ft. (.9M) SJT Cord	3 ft. (.9M) SJT Cord	3 ft. (.9M) SJT Cord	Conduit Box	Conduit Box
max. int. pressure	psi	50	50	50	50	50	50	75	75	75
	bar	3.4	3.4	3.4	3.4	3.4	3.4	5	5	5
max. liquid temp.	°f	190	190	190	190	190	190	200	200	200
	°c	87	87	87	87	87	87	93	93	93
weight packed	lbs.	5 1/2	5 1/2	5 1/2	6	6	6	6 1/2	10	10
	kg.	2.5	2.5	2.5	3	3	3	3	4.5	4.5
materials in contact with solution <sup>Ⓢ</sup>		Glass filled polypropylene, Kynar, Ryton®, Buna N, Ceramic magnet		Glass filled polypropylene, Ceramic shaft & thrust washer, Ceramic magnet, Buna N		Glass filled polypropylene, Kynar®, Ryton®, Buna N, Ceramic magnet		Ryton®, Ceramic, Viton®	Ryton®, Ceramic, Viton®	Kynar®, Ceramic, Viton®

Ⓢ Other materials and voltages available on special order.  
 Ⓢ RPM at wide open flow and 0 head, RPM increases as head is increased.



model AC-2CP-MD  
with air motor



model 2CP-MD



model LC-2CP-MD

# SERIES 2

## 5.5 gpm

Compact and adaptable to many applications, March Series 2 pumps can deliver a maximum flow of 5.5 GPM (18.5 LPM) and handle a maximum head of up to 13.5 ft. (2.7 m) (32 ft. [12 m] when driven by an air motor). Typical applications include etching equipment, photographic and graphic arts processing equipment, garden fountains, ice flakers, plate processors and marine air conditioning. Maximum recommended fluid temperatures are 190° F (87° C) for open-air models, or 130° F (54° C) for submersible models.

Series 2 pumps are available in both open air and epoxy clad submersible models with a variety of options in both materials of construction and inlet and discharge ports. Options for wetted materials include polypropylene, Noryl®, nylon, Buna N rubber and 316 stainless steel. Blast-cooled models have a polypropylene encased impeller magnet. Most models feature Buna N rubber “O” rings. Inlet options are 3/8" FPT, 3/4" MPT or 3/4" (19mm) O.D. smooth, while outlets are offered as 1/4" MPT and 1/2" (12.7mm) O.D. smooth.

Series 2 pumps use 1/35 HP (.021kw), 3200 rpm or 1/40 HP (.018kw), 3450 rpm 115- or 230-volt single phase, 50/60 Hz., air cooled or epoxy encapsulated submersible motors (maroon in color), suitable for both open air or submersible duty. Motors for submersible operation only are color-coded blue. Air motors rated at 1/8 HP (.93kw) are also available for certain environments.

AIR MOTORS

SERIES 2	AIR MOTORS	
	AC-2CP-MD-AM	BC-2CP-MD-AM
max. flow	6.2 gpm	6.2 gpm
	23.5 lpm	23.5 lpm
max. head	32 ft.	32 ft.
	12 m	12 m
inlet	3/8" FPT and 3/4" MPT	3/8" FPT and 3/4" MPT
outlet	1/4" MPT	1/4" MPT
hp	1/8	1/8
kw	.093	.093
rpm <sup>Ⓢ</sup>	3950	3950
max. air pressure	23 psi	23 psi
	1.5 bar	1.5 bar
max. CFM req'd	4	4
motor type	AM	AM
max. int. pressure	50 psi	50 psi
	3.4 bar	3.4 bar
max. liquid temp.	190 °f	190 °f
	87 °c	87 °c
weight packed	4 lbs.	4 lbs.
	1.8 kg.	1.8 kg.
materials in contact with solution <sup>Ⓢ</sup>	Polypropylene, Ceramic, Viton®, Ceramic magnet,	Polypropylene, Ceramic, Viton®, Poly encased magnet

Ⓢ Other materials available on special order.

Ⓢ RPM at wide open flow and 0 head, RPM increases as head is increased.



model AC-2CP-MD



model BC-2CP-MD

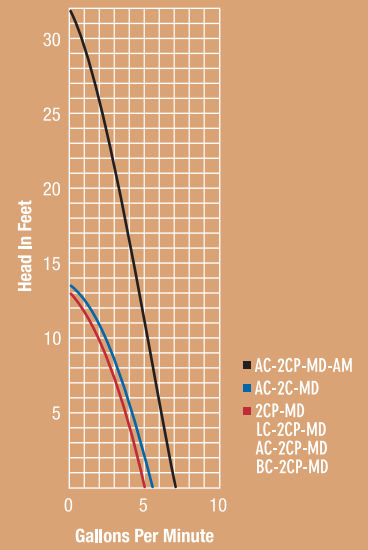

ELECTRIC MOTORS

SERIES 2		2CP-MD	LC-2CP-MD	AC-2C-MD	AC-2CP-MD	AC-2AP-MD	BC-2CP-MD	BC-2AP-MD
max. flow	gpm	5	5	5.5	5	5	5	5
	lpm	18.5	18.5	25	18.5	18.5	18.5	18.5
max. head	ft.	13	13	13	13	13	13	13
	m	2.7	2.7	2.9	2.7	2.7	2.7	2.7
inlet		3/8" FPT and 3/4" MPT	3/8" FPT and 3/4" MPT	3/8" FPT and 3/4" MPT	3/8" FPT and 3/4" MPT	3/4" OD Smooth	3/8" FPT and 3/4" MPT	3/4" OD Smooth
outlet		1/4" MPT	1/4" MPT	1/4" MPT	1/4" MPT	1/2" OD Smooth	1/4" MPT	1/2" OD Smooth
hp		1/35	1/35	1/40	1/40	1/40	1/40	1/40
kw		.021	.021	.018	.018	.018	.018	.018
rpm	us	3200	3200	3450	3450	3450	3450	3450
	metric	2725	2725	2622	2622	2622	2622	2622
volts	us	115	115	115	115	115	115	115
	metric	230	230	230	230	230	230	230
ph		1	1	1	1	1	1	1
hz		50/60	50/60	50/60	50/60	50/60	50/60	50/60
watts	us	54	54	70	70	70	70	70
	metric	55	54	78	78	78	78	78
amp	us	1.0	1.0	1.0	1.0	1.0	1.0	1.0
	metric	.56	.57	.51	.51	.51	.51	.51
motor type		SUB blue ○	TE/SUB maroon ★	AC	AC	AC	BC	BC
electrical connection		6 ft. (3.6M) SJT	6 ft. (3.6M) SJT	3 ft. (1.8M) SJO	3 ft. (1.8M) SJO	3 ft. (1.8M) SJO	3 ft. (1.8M) SJO	3 ft. (1.8M) SJO
max. int. pressure	psi	50	25	50	50	50	50	50
	bar	3.4	1.7	3.4	3.4	3.4	3.4	3.4
max. liquid temp.	°f	130	130	190	190	190	190	190
	°c	54	54	87	87	87	87	87
weight packed	lbs.	5	5	4 1/2	4 1/2	4 1/2	6 1/2	6 1/2
	kg.	2.3	2.3	2	2	2	3	3
materials in contact with solution		Epoxy, Polypropylene, Ceramic, Viton®, SJT cord, Stainless Steel	Polypropylene, Ceramic, Viton®, 316 Stainless Steel	Polypropylene, Ceramic, Buna N, 316 Stainless Steel, Ceramic magnet	Polypropylene, Ceramic, Viton®, Ceramic magnet	Polypropylene, Ceramic, Viton®, Poly encased magnet		

- Other materials and voltages available on special order.
- RPM at wide open flow and 0 head, RPM increases as head is increased.
- Blue color epoxy indicates that pump must be run fully submerged.
- ★ Maroon color epoxy indicates pump can be run in open air or submerged.



model AC-3CP-MD-AM



model LC-3CP-MD



model AC-3CP-MD or BC-3CP-MD

# SERIES 3

## 10 gpm

Simple, versatile and reliable, March Series 3 pumps feature an “orbital” magnetic drive and leak-proof design. They are rated up to 10 GPM (33 LPM) flow and for heads up to 20.5 ft (4.5 m) (39 ft. [13 m] when driven by an air motor). Typical applications include film processors, ice makers, laboratory and medical equipment, vapor degreasers and marine air conditioning systems.

Series 3 pumps are available in both open air and epoxy clad submersible models. A variety of materials of construction ensure compatibility with almost any solution: polypropylene, Delrin®, Viton®, nylon, Buna N rubber, ceramic, and polysulfid plastic (submersible models). Port options are 3/4" FPT inlet with a 1/2" (12.7 mm) MPT outlet or a 3/4" (19 mm) O.D. smooth inlet with a 3/4" (19 mm) O.D. smooth outlet.

Series AC 3 pumps are driven by 1/15 HP (.018 kw), 3200 (60 Hz, air cooled). Series BC 3 are 3450 rpm (50/60 Hz, blast-cooled), all motors are ball bearing motors, epoxy submersible motors are 1/20 HP (.037 kw), 3200 rpm (maroon in color). Air motors rated at 1/8 HP (.093 kw) are also available for certain environments. The 230-volt motors are all rated 50/60 Hz, submersible motors are rated 60Hz or 50 Hz. Specify which voltage and Hz when ordering the submersible models.

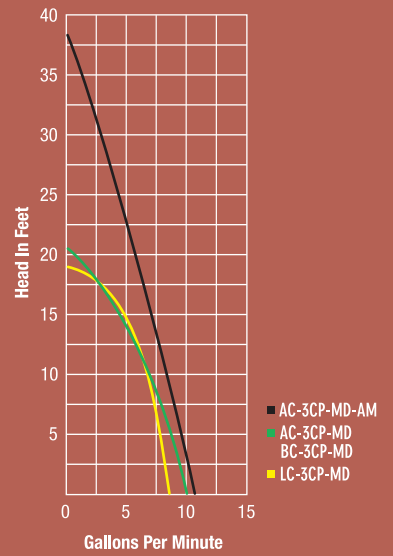

AIR MOTORS

SERIES 3		AC-3CP-MD-AM	AC-3AP-MD-AM	BC-3CP-MD-AM	BC-3AP-MD-AM
max. flow	gpm	10.5	10.5	10.5	10.5
	lpm	42	42	42	42
max. head	ft.	39	39	39	39
	m	13	13	13	13
inlet		3/4" FPT	3/4" OD	3/4" FPT	3/4" OD
outlet		1/2" MPT	3/4" OD	1/2" MPT	3/4" OD
hp		1/8	1/8	1/8	1/8
kw		.093	.093	.093	.093
rpm	us	3150	3150	3150	3150
	metric	3150	3150	3150	3150
volts	us	-	-	-	-
	metric	-	-	-	-
ph		-	-	-	-
max. air pressure	psi	29	29	29	29
	bar	3.4	3.4	3.4	3.4
max. CFM req'd		4	4	4	4
hz		-	-	-	-
watts	us	-	-	-	-
	metric	-	-	-	-
amp	us	-	-	-	-
	metric	-	-	-	-
motor type		AM	AM	AM	AM
electrical connection		-	-	-	-
max. int. pressure	psi	50	50	50	50
	bar	3.4	3.4	3.4	3.4
max. liquid temp.	°f	190	190	190	190
	°c	87	87	87	87
weight packed	lbs.	4 1/2	4 1/2	4 1/2	4 1/2
	kg.	2	2	2	2
materials in contact with solution		Polypropylene, Ceramic magnet, Ceramic, Buna N		Polypropylene, Ceramic, Viton®	

ELECTRIC MOTORS

	LC-3CP-MD*	AC-3CP-MD	AC-3AP-MD	BC-3CP-MD	BC-3AP-MD
max. flow	gpm	8.5	10	10	10
	lpm	31	33	33	33
max. head	ft.	19	20.5	20.5	20.5
	m	4.3	4.5	4.5	4.5
inlet		3/4" FPT	3/4" FPT	3/4" OD	3/4" FPT
outlet		1/2" MPT	1/2" MPT	3/4" OD	1/2" MPT
hp		1/20	1/15	1/15	1/15
kw		.037	.049	.049	.049
rpm	us	3200	3200	3200	3450
	metric	2450	2850	2850	2825
volts	us	115	115	115	115
	metric	230	230	230	230
ph		1	1	1	1
max. air pressure	psi	-	-	-	-
	bar	-	-	-	-
max. CFM req'd		-	-	-	-
hz		60	60	60	50/60
watts	us	120	150	150	120
	metric	100	78	78	78
amp	us	2.0	2.1	2.1	1.7
	metric	1.0	.37	.37	.37
motor type		TE/SUB Maroon *	AC	AC	BC
electrical connection		6 ft (1.8M) SJT	3 ft (9M) SJO	3 ft (9M) SJO	3 ft (9M) SJO
max. int. pressure	psi	25	50	50	50
	bar	1.7	3.4	3.4	3.4
max. liquid temp.	°f	130	190	190	190
	°c	54	87	87	87
weight packed	lbs.	8 1/2	7	7	8
	kg.	3.8	3.1	3.1	3.8
materials in contact with solution		Polypropylene, Epoxy Cupric Nickel, Buna N, Ceramic; when submerged, Sulfil	Polypropylene, Ceramic magnet, Ceramic, Buna N		Polypropylene, Ceramic, Viton®

⊗ Other materials and voltages available on special order.  
 ⊙ RPM at wide open flow and 0 head, RPM increases as head is increased.  
 \* Maroon color epoxy indicates pump can be run in open air or submerged.  
 ★ Stainless steel cooling tube available on special order.





model AC-4C-MD-AM



model AC-4C-MD



model BC-4C-MD

# SERIES 4

## 14 gpm

Series 4 pumps can deliver a maximum flow of 14 GPM (50 LPM), and are capable of serving applications with a maximum head of 21.5 ft. (4.7 m) (49 ft. [15.6 m] when driven by an air motor). Applications include electronic medical equipment, etching machines, photo processing equipment, hospital thermal blankets and food heating cabinets.

Standard construction is of polypropylene, with options for wetted materials that include Ryton® or Kynar®. Ceramic, Buna N rubber, and Viton® for total chemical compatibility. Carbon bushings are available.

Series 4 pumps are available with a 1" FPT inlet and 1/2" MPT outlet, or a 1" (25.4 mm) smooth inlet and a 3/4" (19mm) smooth outlet.

Drive choices are a 1/12 HP (.062 kw), 3450 rpm air-cooled or a 1/10 HP (.074 kw) 3450 rpm blast-cooled, 115-volt single phase, 50/60 Hz. motor. Air motors rated at 1/8 HP (.093 kw) are also available for certain environments. 230-volt motors are all rated 50/60 Hz.

### MODEL 750 PRIMING RESERVOIR

Material in contact with solution:  
Polypropylene and Viton®

Reservoir can be attached to:	Suction Lift - Max. length of inlet pipe
All Series 4 models, AC-5C-MD TE-5C-MD, AC-5C-MD-AM	10 ft. (3 meters)
AC-5.5C-MD, TE-5.5C-MD	7 ft. (2 meters)
DP-6T-MD, TE-6T-MD	6 ft. (1.5 meters)



model BC-4C-MD  
with priming reservoir

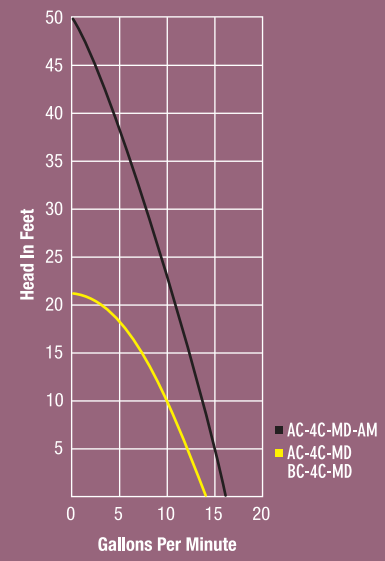

SERIES 4		AIR MOTORS			
		AC-4C-MD-AM	AC-4A-MD-AM	BC-4C-MD-AM	BC-4A-MD-AM
max. flow	gpm	16	16	16	16
	lpm	68	68	68	68
max. head	ft.	49	49	49	49
	m	15.6	15.6	15.6	15.6
inlet		1" FPT	1" OD	1" FPT	1" OD
outlet		1/2" MPT	3/4" OD	1/2" MPT	3/4" OD
hp		1/8	1/8	1/8	1/8
kw		.093	.093	.093	.093
rpm	us	3550	3550	3550	3550
	metric	-	-	-	-
volts	us	-	-	-	-
	metric	-	-	-	-
ph		-	-	-	-
max. air pressure	psi	65	65	65	65
	bar	4.5	4.5	4.5	4.5
max. CFM req'd		8	8	8	8
hz		-	-	-	-
watts	us	-	-	-	-
	metric	-	-	-	-
amp	us	-	-	-	-
	metric	-	-	-	-
motor type		AM	AM	AM	AM
electrical connection		-	-	-	-
max. int. pressure	psi	50	50	50	50
	bar	3.4	3.4	3.4	3.4
max. liquid temp.	°f	190	190	190	190
	°c	87	87	87	87
weight packed	lbs.	5	5	5	5
	kg.	2.3	2.3	2.3	2.3
materials in contact with solution		Polypropylene, Ceramic, Ceramic magnet, Buna N		Polypropylene, Ceramic, Viton®	

		ELECTRIC MOTORS			
		AC-4C-MD	AC-4A-MD	BC-4C-MD	BC-4A-MD
max. flow	gpm	14	14	14	14
	lpm	50	50	50	50
max. head	ft.	21.5	21.5	21.5	21.5
	m	4.7	4.7	4.7	4.7
inlet		1" FPT	1" OD	1" FPT	1" OD
outlet		1/2" MPT	3/4" OD	1/2" MPT	3/4" OD
hp		1/12	1/12	1/10	1/10
kw		.062	.062	.074	.074
rpm	us	3450	3450	3450	3450
	metric	2700	2700	2700	2700
volts	us	115	115	115	115
	metric	230	230	230	230
ph		1	1	1	1
max. air pressure	psi	-	-	-	-
	bar	-	-	-	-
max. CFM req'd		-	-	-	-
hz		50/60	50/60	50/60	50/60
watts	us	150	150	200	200
	metric	126	126	132	132
amp	us	1.3	1.3	1.65	1.65
	metric	.57	.57	.55	.55
motor type		AC	AC	BC	BC
electrical connection		3 ft (.9M) SJO	3 ft (.9M) SJO	3 ft (.9M) SJO	3 ft (.9M) SJO
max. int. pressure	psi	50	50	50	50
	bar	3.4	3.4	3.4	3.4
max. liquid temp.	°f	190	190	190	190
	°c	87	87	87	87
weight packed	lbs.	8 1/2	8 1/2	10	10
	kg.	3.8	3.8	4.5	4.5
materials in contact with solution		Polypropylene, Ceramic, Ceramic magnet, Buna N		Polypropylene, Ceramic, Viton®	

⊗ Other materials and voltages available on special order.  
 ⊙ RPM at wide open flow and 0 head, RPM increases as head is increased.



model AC-5C-MD-AM



model 5C-MD



model AC-5C-MD

# SERIES 5

## 18 gpm

March Series 5 pumps are ideal for a wide variety of applications involving highly corrosive chemicals, such as film processor chemical recirculation, refrigerators, small scrubbers and detergent mixers. Models constructed of Kynar® are typically used in the plating industry to pump strong halogen solutions and concentrated chromic or sulfuric acids. They are also excellent choices for computer cooling, carbon arc furnace cooling and marine air conditioners.

Series 5 pumps are rated up to 18 GPM (60.5 LPM) flow and for heads up to 29 ft. (6.3m) (50 ft. [16m] when driven by an air motor).

Variations in wetted materials on the Series 5 are some of the widest in the March line, affording maximum compatibility with a wide variety of solutions. These materials include polypropylene, Ryton®, carbon-filled Kynar, 316 stainless steel, ceramic, Buna N rubber, and Viton®. Carbon bushings are also available, which also afford a dry run capability not found in other models. The impeller diameter may be trimmed to enable efficient use with solutions with a specific gravity in excess of 1.0.

14.5 to 18 GPM (60 to 60.5 LPM) models utilize 1/8 HP (.093 kw), 2800 or 3200 rpm, submersible or air-cooled 115-volt, single phase, 50/60 Hz. motors. 18 GPM (60.5 LPM) models have a 1/5 HP, 3450 rpm, 115/230-volt, single phase, 50/60 Hz., totally enclosed fan-cooled motor. Air motors rated at 1/8 HP (.093 kw) are also available for certain environments. Explosion-proof motors are also available. All series 5 pumps except stainless steel are available with either threaded or hose type connections. The stainless steel version has threaded connections. Flanged connection can be special ordered.

### AIR MOTORS

SERIES 5		AIR MOTORS					
		AC-5C-MD-AM	AC-5A-MD-AM	TE-5A-MD-AM	TE-5C-MD-AM	TE-5K-MD-AM	TE-5S-MD-AM
max. flow	gpm	16.5	16.5	16.5	16.5	16.5	16.5
	lpm	60.5	60.5	60.5	60.5	60.5	60.5
max. head	ft.	50	50	50	50	50	50
	m	16	16	16	16	16	16
inlet		1" FPT	1" OD	1" OD	1" FPT	1" FPT	1" FPT
outlet		1/2" MPT	3/4" OD	3/4" OD	1/2" MPT	1/2" MPT	1/2" MPT
hp		1/8	1/8	1/8	1/8	1/8	1/8
kw		.093	.093	.093	.093	.093	.093
rpm	⊙	2900	2900	2900	2900	2900	2900
max. air pressure	psi	60	60	60	60	60	60
	bar	4	4	4	4	4	4
max. CFM req'd		7	7	7	7	7	7
motor type		AM	AM	AM	AM	AM	AM
max. int. pressure	psi	50	50	50	50	75	200
	bar	3.4	3.4	3.4	3.4	5	13
max. liquid temp.	°f	190	190	190	190	200	250
	°c	87	87	87	87	93	121
weight packed	lbs.	5	5	5	5	5	7 1/2
	kg.	2.3	2.3	2.3	2.3	2.3	3
materials in contact with solution		Polypropylene, Ceramic Buna N, Ceramic magnet		Polypropylene, Ceramic, Viton®		Carbon/Kynar®, Ceramic, Viton®	316 St. Steel, Viton®, Ceramic, Carbon bushing

⊙ Other materials and voltages available on special order.

⊙ RPM at wide open flow and 0 head, RPM increases as head is increased.



model TE-5S-MD

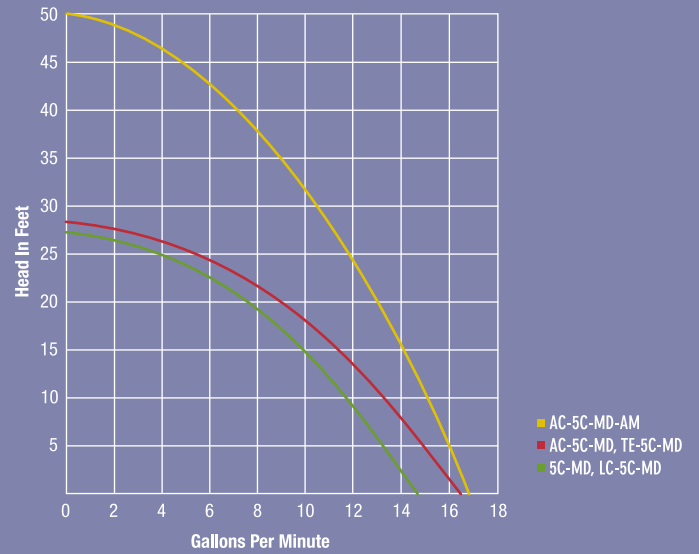

ELECTRIC MOTORS

SERIES 5		5C-MD	LC-5C-MD	AC-5C-MD	AC-5A-MD	TE-5A-MD	TE-5C-MD	TE-5K-MD	TE-5S-MD
max. flow	gpm	14.5	14.5	17	17	18	18	18	18
	lpm	60	60	60	60	60.5	60.5	60.5	60.5
max. head	ft.	27	27	27	27	29	29	29	29
	m	6	6	6	6	6.3	6.3	6.3	6.3
inlet ★		1" FPT	1" FPT	1" FPT	1" OD	1" OD	1" FPT	1" FPT	1" FPT
outlet ★		1/2" MPT	1/2" MPT	1/2" MPT	3/4" OD	3/4" OD	1/2" MPT	1/2" MPT	1/2" MPT
hp		1/8	1/8	1/8	1/8	1/5	1/5	1/5	1/5
kw		.093	.093	.093	.093	.149	.149	.149	.149
rpm ⊕	us	2800	2800	3200	3200	3450	3450	3450	3450
	metric	2750	2750	2750	2750	2800	2800	2800	2800
volts ⊕	us	115	115	115	115	115/230	115/230	115/230	115/230
	metric	230	230	230	230	115/230	115/230	115/230	115/230
ph		1	1	1	1	1	1	1	1
hz		50/60	50/60	50/60	50/60	50/60	50/60	50/60	50/60
watts	us	250	250	227	227	200	200	200	200
	metric	143	143	220	220	220	220	220	220
amp	us	2.1	2.1	2.2	2.2	2.2/1.1	2.2/1.1	2.2/1.1	2.2/1.1
	metric	1.0	1.0	1	1	1	1	1	1
motor type		SUB BLUE	TE/SUB Maroon ★	AC	AC	TEFC	TEFC	TEFC	TEFC
electrical connection		6 ft (1.8M) SJT w/plug	6 ft (1.8M) SJT w/plug	3 ft (.9M) SJO	3 ft (.9M) SJO	Conduit Box	Conduit Box	Conduit Box	Conduit Box
max. int. pressure	psi	50	50	50	50	50	50	75	200
	bar	3.4	3.4	3.4	3.4	3.4	3.4	5	13
max. liquid temp.	°f	130	130	190	190	190	190	200	250
	°c	54	54	87	87	87	87	93	121
weight packed	lbs.	18	18	9 1/2	9 1/2	15 1/2	15 1/2	15 1/2	18
	kg.	8	8	4.5	4.5	7	7	7	8
materials in contact with solution ⊕		Stainless Steel, Epoxy, Polypropylene, SJT Cord, Buna N, Ceramic magnet		Polypropylene, Ceramic, Buna N, Ceramic magnet		Polypropylene, Ceramic, Viton®		Carbon/Kynar®, Ceramic, Viton®	316 Stainless Viton®, Ceramic, Carbon bushing

⊕ Other materials and voltages available on special order.  
 ⊕ RPM at wide open flow and 0 head, RPM increases as head is increased.  
 ★ Maroon color epoxy indicates pump can be run in open air or submerged.  
 BSP threads available on special order on plastic pumps.



model TE-5.5C-MD  
with AC motor



model TE-5.5S-MD

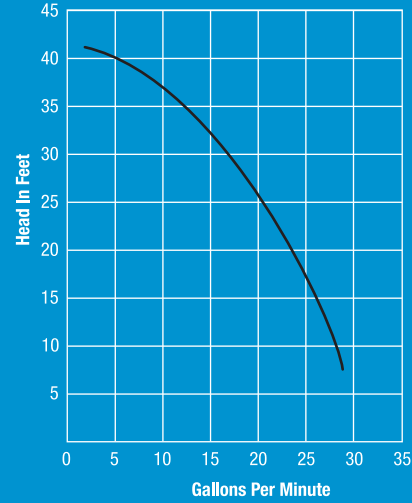

TE-5.5C-MD

# SERIES 5.5

## 30 gpm

The 5.5 series pumps are the first in the March product line to employ an involute design with a closed impeller magnet assembly. They can deliver a maximum flow of 30 GPM (110 LPM), and are capable of serving applications with a maximum head of 41 ft. (9m). Able to handle chemicals of all kinds at temperatures up to 190° F (87° C), uses range from icemakers to film processors and silver recovery systems. Units with Kynar® plastic construction can handle strong halogen solutions and certain chromic or sulfuric acid solutions. Other options for wetted materials include glass filled polypropylene, ceramic, Viton®, and 316 stainless steel. Optional bushings, “O” rings and spindle combinations are available.

Drive motors are a 1/5 HP (.149 kw), 3200 rpm, 115-volt single phase air-cooled or a 1/3 HP (.248 kw) 3450 rpm, 115/230-volt single phase or 230/460-volt three-phase totally enclosed, 50/60 Hz. motor. Explosion-proof motors are also available. Standard port configuration is a 1" FPT inlet with a 3/4" MPT outlet.

- ⊙ Other materials and voltages available on special order.
- ⊙ RPM at wide open flow and 0 head, RPM increases as head is increased.
- ◇ Priming reservoir available.

BSP threads available on special order on plastic pumps.

Explosion proof motors available. Carbon bushings available for dry running. Other bushing materials available for various chemical solution. Flanges are available on special order.

### ELECTRIC MOTORS

SERIES 5.5		TE-5.5C-MD ◇ W/AC MOTOR	TE-5.5C-MD ◇	TE-5.5K-MD	TE-5.5S-MD
max. flow	gpm	30	30	30	30
	lpm	110	110	110	110
max. head	ft	40	41	41	41
	m	8.5	9	9	9
inlet		1" FPT	1" FPT	1" FPT	1" FPT
outlet		3/4" MPT	3/4" MPT	3/4" MPT	3/4" MPT
hp		1/5	1/3	1/3	1/3
kw		.149	.248	.248	.248
rpm ⊙	us	3200	3450	3450	3450
	metric	2799	2850	2850	2850
volts ⊙	us	115	115/230	115/230	115/230
			230/460	230/460	230/460
	metric	230	115/230	115/230	115/230
		230/460	230/460	230/460	
ph		1	1, 3	1, 3	1, 3
hz		50/60	50/60	50/60	50/60
watts	us	290	400, 455	400, 455	400, 455
	metric	370	300, 336	300, 336	300, 336
amp	us	2.6	3.6/1.8	3.6/1.8	3.6/1.8
			1.3/6	1.3/6	1.3/6
	metric	1.7	1.35, 1.26	1.35, 1.26	1.35, 1.26
motor type		AC	TEFC	TEFC	TEFC
electrical connection		Conduit Box	Conduit Box	Conduit Box	Conduit Box
max. int. pressure	psi	50	50	75	200
	bar	3.4	3.4	5	13
max. liquid temp.	°f	190	190	200	250
	°c	87	87	93	121
weight packed	lbs.	15 1/2	34 1/2	35	39
	kg.	7	15.5	16	17.5
materials in contact with solution ⊙		Polypropylene, Ceramic, Viton®	Carbon filled Kynar®, Ceramic, Viton®	316 Stainless Steel, Viton®, Ceramic, Carbon bushing	



model DP-6T-MD



model TE-6T-MD

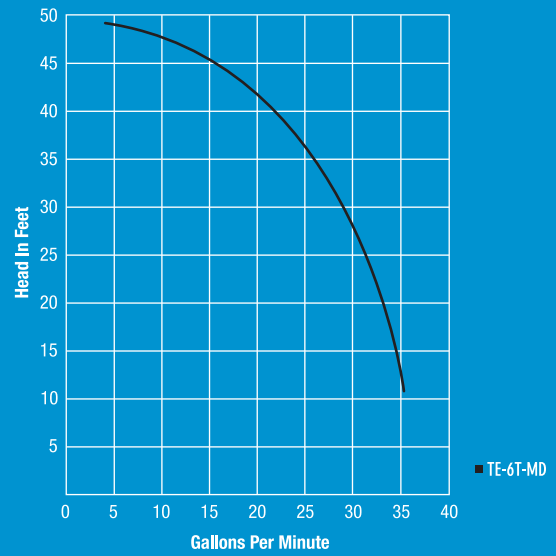

# SERIES 6

## 38 gpm

ELECTRIC MOTORS

SERIES 6		DP-6T-MD ◊	TE-6T-MD ◊	TE-6T-MD	TE-6K-MD	TE-6K-MD
max. flow	gpm	38	38	38	38	38
	lpm	110.5	110.5	110.5	110.5	110.5
max. head	ft.	49	49	49	49	49
	m	11	11	11	11	11
inlet		1" FPT	1" FPT	1" FPT	1" FPT	1" FPT
outlet		3/4" MPT	3/4" MPT	3/4" MPT	3/4" MPT	3/4" MPT
hp		1/2	1/2	1/2	1/2	1/2
kw		.372	.372	.372	.372	.372
rpm	us	3450	3450	3450	3450	3450
	metric	2850	2850	2850	2850	2850
volts	us	115/230	115/230	230/460	115/230	230/460
	metric	115/230	115/230	230/460	115/230	230/460
ph		1	1	3	1	3
hz	us	60	50/60	50/60	50/60	50/60
	metric	50	50/60	50/60	50/60	50/60
watts	us	620	600	470	600	470
	metric	630	572	452	572	452
amp	us	8.8/4.4	7.4/3.7	1.5/75	7.4/3.7	1.5/75
	metric	8.8/4.58	7.4/3.7	1.56/75	7.4/3.7	1.56/75
motor type		DP	TEFC	TEFC	TEFC	TEFC
electrical connection		Conduit Box	Conduit Box	Conduit Box	Conduit Box	Conduit Box
max. int. pressure	psi	50	50	50	75	75
	bar	3.4	3.4	3.4	3.4	3.4
max. liquid temp.	°f	190	190	190	200	200
	°c	87	87	87	93	93
weight packed	lbs.	25 1/2	34 1/2	33	34 1/2	33
	kg.	11.5	15.5	15	15.5	15
materials in contact with solution		Glass filled polypropylene and Ryton®, Ceramic, Viton®, Teflon/Ryton bushing			Carbon filled Kynar®, Ceramic, Viton®, Carbon bushing	

Suitable for a range of applications from commercial-size aquariums and D.I. water systems to etching equipment and electrical discharge machinery (EDM), Series 6 pumps are the only models in the March line equipped with a drip-proof motor (DP) as standard. Other motors are totally enclosed fan-cooled, single and three-phase and explosion-proof. All are rated at 1/2HP (.372 kw), 3450 rpm, 115/230-volt 50/60 Hz, single-phase or 230/460-volt three-phase, 50/60 Hz.

Series 6 pumps have a capacity of up to 38 GPM (110.5 LPM) with a maximum of 46 feet (11m) of head. They can be made compatible with a wide range of chemicals through a myriad of "O" rings, bushings and spindle material alternatives available. Models manufactured of Kynar® (PVDF) are particularly suited for difficult solutions, such as those based on halogens or chromic and sulfuric acids. Additional material options include glass-filled polypropylene, Ryton®, ceramic and Viton®.

Standard ports are a 1" FPT inlet with a 3/4" MPT outlet. Ports with a 1-11 BSP female inlet and 1 1/4-14 BSP with "O" ring groove male outlet are available on special order.

- ⊙ Other materials and voltages available on special order.
- ⊙ RPM at wide open flow and 0 head, RPM increases as head is increased.
- ◊ Priming reservoir available.

*BSP threads available on special order on plastic pumps.*

*Explosion proof motors available. Carbon bushings available for dry running. Other bushing materials available for various chemical solution. Flanges are available on special order.*



model TE-7R-MD



model TE-7S-MD



model SP-TE-7P-MD

# SERIES 7

## 53 gpm

Series 7 totally enclosed pumps, with capacities up to 53 GPM (180 LPM) or a maximum 60 ft. (12m) head, are the “workhorses” of the March product line. Typical applications include computer cooling, photo processing, graphic printing, ion exchange recovery/ development, and aquariums.

The standard motor used in Series 7 pumps is a true 3/4HP (.558 kw). In addition, a 1 HP and 1 1/2 HP motor can be supplied, as well as various explosion-proof and chemical duty motors. A 1 HP self-priming model, with a suction lift capability of 10 ft. (3m), may be specified for applications where gravity feed is not available. Installations using such motors require no openings in the side of the fluid container.

Various specific gravities can be handled by trimming the diameter of the impeller magnet assembly. The standard 3.750" impeller may be reduced in size to a 3.125" to accommodate specific gravities of up to 2.0. The front impeller shroud can be removed for special applications.

Wetted materials are made of polypropylene, with the exception of the rear housing, which is manufactured of Ryton® for additional strength. Additional options for wetted material include all polypropylene, ceramic, all Kynar® (ideal for handling difficult liquids such as strong halogen, chromic or sulfuric acid solutions), Viton®, 316 stainless steel and Hastelloy®. Bushing material (the selection of which depends on the nature of the solution being pumped) ranges from standard carbon to mica-filled Teflon® and a Teflon®/Ryton®/carbon composite. To insure complete material/solution compatibility, a variety of spindles are also available. A ceramic spindle is standard, while stainless steel and Hastelloy® are also available. Each can handle solutions that contain minute solids.

Standard ports are a 1 1/2" FPT inlet with a 1" MPT outlet. Ports with a 1 1/2-11 BSP Female inlet and 1 1/2-BSP with “O” ring groove male outlet are available on special order.



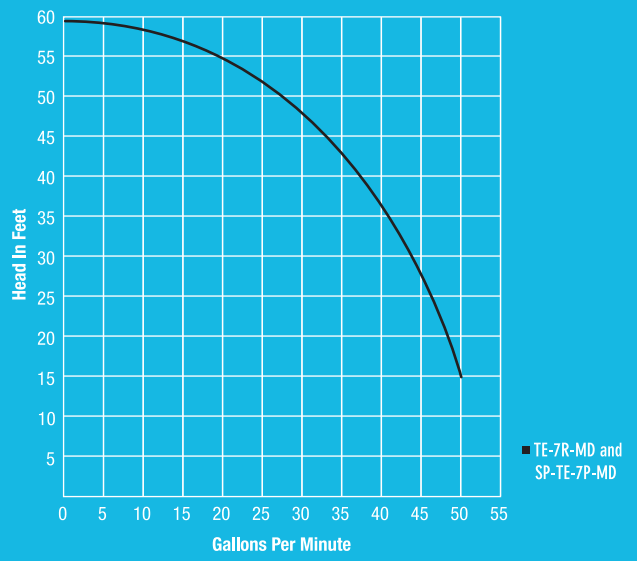
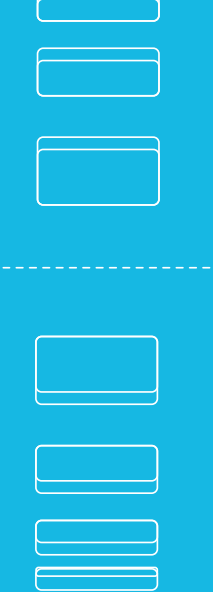

ELECTRIC MOTORS

SERIES 7		TE-7R-MD	TE-7R-MD	TE-7K-MD	TE-7K-MD	TE-7S-MD	TE-7S-MD
max. flow	gpm	53	53	53	53	53	53
	lpm	180	180	180	180	180	180
max. head	ft.	60	60	60	60	60	60
	m	12	12	12	12	12	12
inlet		1 1/2" FPT	1 1/2" FPT	1 1/2" FPT	1 1/2" FPT	1 1/2" FPT	1 1/2" FPT
outlet		1" MPT	1" MPT	1" MPT	1" MPT	1" MPT	1" MPT
hp		3/4		3/4		1	
kw		.558		.558		.745	
rpm <sup>⊙</sup>	us	3450		3450		3450	
	metric	2850		2850		2850	
volts <sup>⊙</sup>	us	115/230	230/460	115/230	230/460	115/230	230/460
	metric	115/230	230/460	115/230	230/460	115/230	230/460
ph		1	3	1	3	1	3
hz	us	50/60	50/60	50/60	50/60	50/60	50/60
	metric	50/60	50/60	50/60	50/60	50/60	50/60
watts	us	830	768	830	768	1140	1045
	metric	805	717	805	717	740	653
amp	us	10.0/5.0	2.2/1.1	10.0/5.0	2.2/1.1	11.8/5.9	3.0/1.5
	metric	11.4/5.7	2.5/1.25	11.4/5.7	2.5/1.25	12.4/6.2	3.2/1.5
motor type		TEFC	TEFC	TEFC	TEFC	TEFC	TEFC
electrical connection		Conduit Box	Conduit Box	Conduit Box	Conduit Box	Conduit Box	Conduit Box
max. int. pressure	psi	50	50	75	75	200	200
	bar	3.4	3.4	5	5	13	13
max. liquid temp.	°f	190	190	200	200	250	250
	°c	87	87	93	93	121	121
weight packed	lbs.	38 1/2	33	38 1/2	33	49 1/2	44
	kg.	17.5	15	17.5	15	22.5	20
materials in contact with solution <sup>⊙</sup>		Glass filled polypropylene and Ryton <sup>®</sup> , Ceramic, Viton <sup>®</sup> , Teflon/Ryton bushing		Carbon filled Kynar <sup>®</sup> , Ceramic Viton <sup>®</sup> , Carbon bushing		316 Stainless Steel, Ceramic, Viton <sup>®</sup> , Carbon bushing	

SELF-PRIMING CENTRIFUGAL PUMPS

	SP-TE-7P-MD	SP-TE-7P-MD
max. flow	53 gpm 180 lpm	53 gpm 180 lpm
max. head	57 ft. 12 m	57 ft. 12 m
inlet	1 1/2" MPT	1 1/2" MPT
outlet	1" MPT	1" MPT
hp	1	1
kw	.745	.745
rpm <sup>⊙</sup>	us: 3450	us: 3450
	metric: 2850	metric: 2850
volts <sup>⊙</sup>	us: 115/208/230	us: 208/230/460
	metric: 115/208/230	metric: 208/230/460
ph	1	3
hz	us: 60	us: 60
	metric: 50/60	metric: 50/60
watts	us: -	us: -
	metric: -	metric: -
amp	us: 11.8/6.4/5.9	us: 3.2/2.9/1.45
	metric: 11.8/6.4/5.9	metric: 3.2/2.9/1.45
motor type	TEFC	TEFC
electrical connection	Conduit Box	Conduit Box
max. int. pressure	psi: 50	psi: 50
	bar: 3.4	bar: 3.4
max. liquid temp.	°f: 190	°f: 190
	°c: 87	°c: 87
weight packed	lbs: 75	lbs: 70
	kg: 34	kg: 32
materials in contact with solution <sup>⊙</sup>	Glass filled polypropylene, Ceramic, Viton <sup>®</sup> , Carbon bushing, (Carbon filled Kynar <sup>®</sup> available)	

⊙ Other materials and voltages available on special order.  
 ⊙ RPM at wide open flow and 0 head, RPM increases as head is increased.  
 BSP threads available on special order on plastic pumps.  
 Explosion proof motors available on all models. Carbon bushings available for dry running.  
 Other bushing materials available for various chemical solutions.



model TE-7.5K-MD

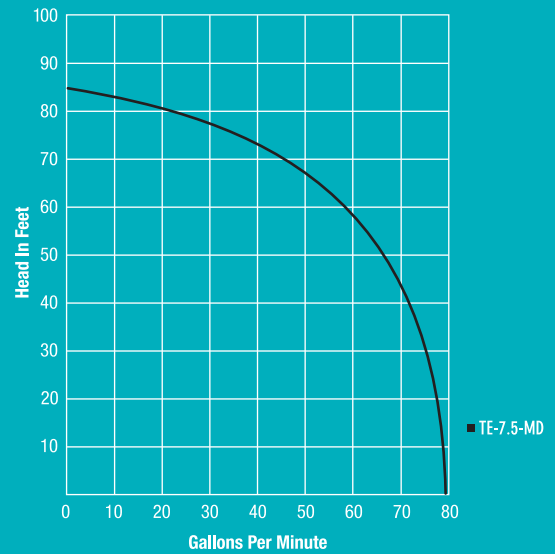

# SERIES 7.5

## 82 gpm

Series 7.5 pumps are the only ones in the March product line with all molded parts constructed of natural Kynar®. This makes them ideal for super sensitive applications where even a trace of foreign matter is unacceptable, such as microchip manufacturing. Various bushing materials are available for such applications where purity of solutions is critical.

Other component materials are Viton®, Teflon® or ethylene propylene “O” rings, ceramic thrust washer and spindle and carbon bushings.

Flow rates range from 10 GPM (35 LPM) minimum to 82 GPM (268 LPM) maximum. Head ranges from 0 ft. to a maximum of 85 ft. (18m). Other application examples include plating equipment and D.I. water systems.

Standard with the Series 7.5 pump is a 2 HP (1.49 kw), 230/460-volt, three-phase, totally enclosed motor. Severe duty and explosion-proof motors are also available. Standard port configuration is a 2" MPT inlet with a 1 1/2" MPT outlet.

SERIES 7.5		ELECTRIC MOTORS
		TE-7.5K-MD
max. flow	gpm	82
	lpm	268
max. head	ft.	85
	m	18
inlet		2" MPT
outlet		1 1/2" MPT
hp		2
kw		1.490
rpm	us	3450
	metric	2850
volts	us	230/460
	metric	230/460
ph		3
hz		50/60
watts	us	1880
	metric	1176
amp	us	5.2/2.6
	metric	5.2/2.6
motor type		TEFC
electrical connection		Conduit Box
max. int. pressure	psi	60
	bar	5
max. liquid temp.	°f	190
	°c	87
weight packed	lbs.	53
	kg.	26
materials in contact with solution		Natural PVDF, Ceramic, Viton®, Carbon bushing

⊗ Other materials and voltages available on special order.  
 ⊗ RPM at wide open flow and 0 head, RPM increases as head is increased.

*Explosion proof motors available on all models. Carbon bushings available for dry running. Other bushing materials available for various chemical solutions.*



model TE-8C-MD

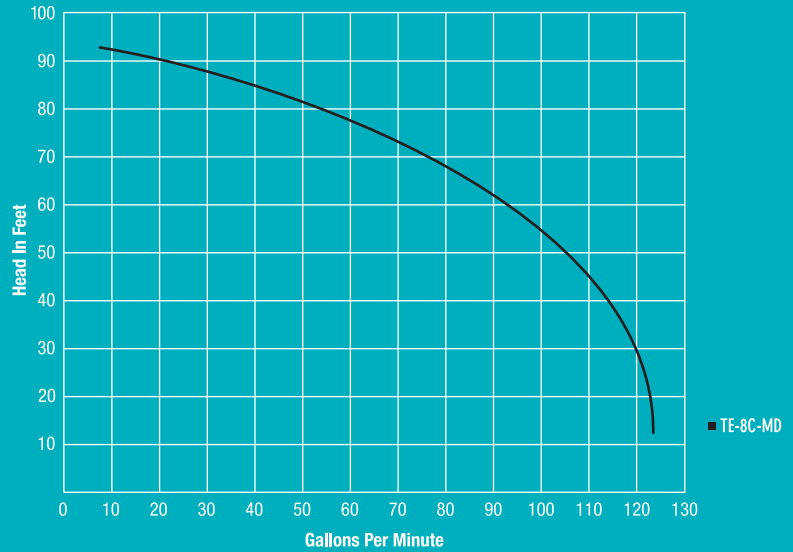

P A G E 2 5  
www.marchpump.com

# SERIES 8

## 125 gpm

SERIES 8		ELECTRIC MOTORS		
		TE-8C-MD	TE-8K-MD	TE-8S-MD
max. flow	gpm	125	125	125
	lpm	400	400	400
max. head	ft.	95	95	95
	m	20	20	20
inlet		2" MPT	2" MPT	2" MPT
outlet		1 1/2" MPT	1 1/2" MPT	1 1/2" MPT
hp		3	3	5
kw		2.235	2.235	3.725
rpm <sup>Ⓞ</sup>	us	3450	3450	3450
	metric	2850	2850	2850
volts <sup>Ⓞ</sup>	us	230/460	230/460	230/460
	metric	230/460	230/460	230/460
ph		3	3	3
hz	us	60	60	60
	metric	50	50	50
watts	us	2625	2625	5200
	metric	2010	2010	2765
amp	us	7.8/3.9	7.8/3.9	13.8/6.9
	metric	7.8/3.9	7.8/3.9	11.8/5.9
motor type		TEFC	TEFC	TEFC
electrical connection		Conduit Box	Conduit Box	Conduit Box
max. int. pressure	psi	50	75	200
	bar	3.4	5	13
max. liquid temp.	°f	190	200	250
	°c	87	93	121
weight packed	lbs.	160	160	180
	kg.	72.5	72.5	81.5
materials in contact with solution <sup>Ⓞ</sup>		Polypropylene front housing, Kynar <sup>®</sup> PVDF rear, Viton <sup>®</sup> , Teflon <sup>®</sup> /Ryton bushing, Ceramic	Carbon filled, Kynar <sup>®</sup> , Ceramic, Viton <sup>®</sup> , Carbon bushing	316 Stainless Steel, Viton <sup>®</sup> , Ceramic, Carbon bushing

Ⓞ Other materials and voltages available on special order.  
 Ⓞ RPM at wide open flow and 0 head, RPM increases as head is increased.  
 BSP threads available on special order on plastic pumps.

March Series 8 totally enclosed pumps, with standard wetted parts of glass-filled polypropylene, carbon-filled Kynar<sup>®</sup> and 316 stainless steel, are the ideal choice for handling difficult liquids, such as strong halogen or chromic, and sulfuric acid solutions. Typical applications range from computer cooling systems and waste treatment plants to plating operations, photo processors and chemical plants.

Flow rates range from 25 GPM (90 LPM) minimum to 125 GPM (400 LPM) maximum at heads from 0 ft. to 95 ft. (20m) maximum.

Standard bushing materials include carbon, Teflon<sup>®</sup>/Ryton<sup>®</sup>/carbon composite and mica-filled Teflon<sup>®</sup>. These may be used with either glass-filled polypropylene, Kynar<sup>®</sup> or 316 stainless steel impeller magnet assemblies to insure complete chemical compatibility. The standard spindle for all three models is ceramic, while Hastelloy<sup>®</sup> and stainless steel are available on special order for enhanced chemical resistance. Both the front and rear thrust washers are available in ceramic, Hastelloy<sup>®</sup>, or (exclusive to Series 8 and Series 10 models) silicon carbide. Viton<sup>®</sup>, ethylene propylene or Teflon<sup>®</sup> "O" rings are available to further ensure chemical compatibility.

Available 3450 rpm totally enclosed drive motors are the standard 3HP (2.235 kw), three-phase 230/460-volt and the 5 HP (3.725 kw), three-phase 230/460-volt explosion-proof model (used in the stainless steel pump). A steel frame totally enclosed motor that is not chemical-resistant is also available. Standard port configuration is a 2" MPT inlet with a 1 1/2" MPT outlet.



model # TE-10K-MD

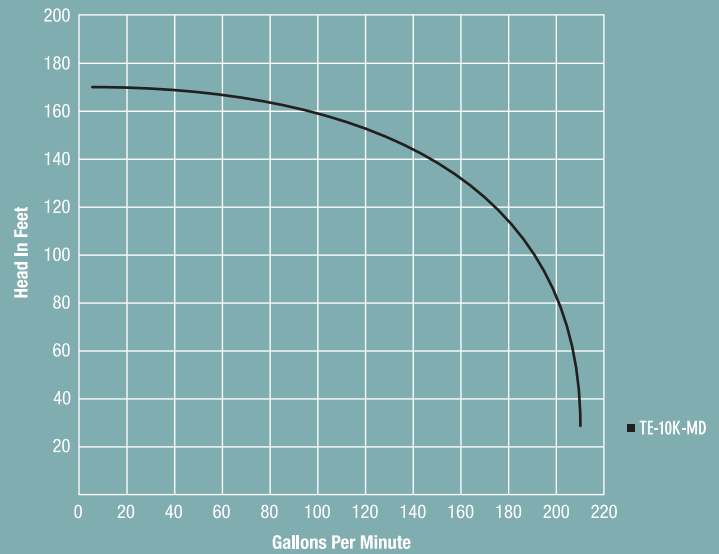

# SERIES 10

## 210 gpm

The largest and newest chemical pump in the March product line, the innovative Series 10 is an ideal transfer pump for many strong acid and caustic chemical solutions, such as those based on halogens or chromic and sulfuric acids. Made of carbon-filled Kynar® plastic (PVDF), it is designed for complete chemical compatibility. Other materials include carbon-filled Kynar®, ceramic, and Viton®. Standard bushings are carbon.

Flow rates range from 50 GPM (175 LPM) minimum to 210 GPM (680 LPM) maximum. Head ranges from 0 to 170 ft. (35m) maximum. To insure smooth operation with various specific gravities over 1.0, the impeller magnet assembly may be trimmed to a minimum diameter of 5.250" (135 mm).

The electric motor drive is a 10 HP (7.45 kw), 230/460-volt three-phase, totally enclosed chemical duty motor. An explosion-proof 15 HP is available on special order. Standard port configuration is a 3" MPT inlet with a 2" MPT outlet.

Because the Series 10 pump is manufactured of only one material for some rather specific applications, the variations in bushings, thrust washer and static "O" rings are limited. A pump application questionnaire must be completed and submitted to the March Engineering Department to ensure proper job-specific design.

SERIES 10		ELECTRIC MOTORS
		TE-10K-MD
max. flow	gpm	210
	lpm	680
max. head	ft.	170
	m	35
inlet		3" MPT
outlet		2" MPT
hp		10
kw		7.450
rpm <sup>Ⓢ</sup>	us	3450
	metric	2850
volts <sup>Ⓢ</sup>	us	230/460
	metric	230/460
ph		3
hz	us	60
	metric	50
watts	us	8800
	metric	6530
amp	us	27/13.5
	metric	27/13.5
motor type		TEFC
electrical connection		Conduit Box
max. int. pressure	psi	75
	bar	5
max. liquid temp.	°f	200
	°c	93
weight packed	lbs.	220
	kg.	99.5
materials in contact with solution <sup>Ⓢ</sup>		Carbon filled, Kynar®, Ceramic, Viton®, Carbon bushing

Ⓢ Other materials and voltages available on special order.  
 Ⓢ RPM at wide open flow and 0 head, RPM increases as head is increased.



model 821-BR



model 821-CI-T

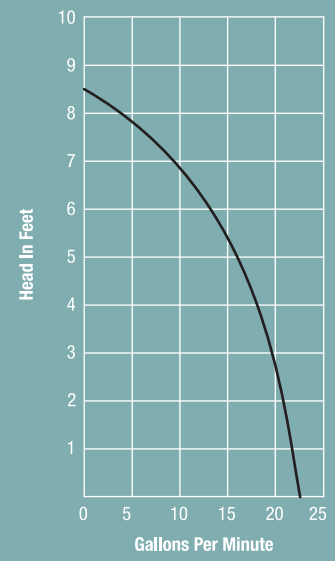

# HYDRONIC PUMPS

## 3 to 22 gpm

SERIES 821		ELECTRIC MOTORS			
		821-CI	821-CI-T	821-BR	821-BR-T
max. flow	gpm	22	22	22	22
	lpm	63.2	63.2	63.2	63.2
max. head	ft.	8.5	8.5	8.5	8.5
	m	1.7	1.7	1.7	1.7
inlet		Flange	3/4" FPT	Flange	3/4" FPT
outlet		Flange	3/4" FPT	Flange	3/4" FPT
hp		1/20	1/20	1/20	1/20
kw		.037	.037	.037	.037
rpm <sup>Ⓢ</sup>	us	1600	1600	1600	1600
	metric	1350	1350	1350	1350
volts <sup>Ⓢ</sup>	us	115	115	115	115
	metric	230	230	230	230
ph		1	1	1	1
hz		50/60	50/60	50/60	50/60
watts	us	110	110	110	110
	metric	122	122	122	122
amp	us	1.8	1.8	1.8	1.8
	metric	.81	.81	.81	.81
motor type		BC	BC	BC	BC
electrical connection		Conduit Box	Conduit Box	Conduit Box	Conduit Box
max. int. pressure	psi	150	150	150	150
	bar	10	10	10	10
max. liquid temp.	°f	250	250	250	250
	°c	121	121	121	121
weight packed	lbs.	14	11 1/2	14 1/2	12
	kg.	6.5	5	6.5	5.5
materials in contact with solution★		Cast Iron, 304 Stainless Steel, Ryton® Plastic, Carbon Bushing, Nitrile/Fibre Gasket		Bronze, 304 Stainless Steel, Ryton® Plastic, Carbon Ceramic, Nitrile/Fibre Gasket	

Ⓢ Other materials and voltages available on special order.  
 Ⓢ RPM at wide open flow and 0 head, RPM increases as head is increased.

### The Ultimate in Reliability in Circulating Pumps for Industrial/Hydrionic/Solar Applications.

Depending on application, March hydronic pumps are available in a variety of materials, including plastic, bronze, stainless steel, and cast iron. Specific models are designed to operate with fluid temperatures as high as 350° F (176° C), such as in hot water systems or with hot oil for food products. Special designs can withstand temperatures up to 500° F (260° C).

Models are available for use on 12- and 24-volt DC systems (for uses such as heating systems on public buses) as well as 115- or 230-volt AC systems (popular for use in domestic, industrial and commercial hot water and solar heating applications). Maximum flow rates range from 5.5 GPM (13.7 LPM) to 7.5 GPM (.22 LPM) for DC-powered units, and from 4.5 GPM (13.7 LPM) to 8 GPM (28 LPM) with AC-powered models. Because the motors can be removed without draining the system, service is greatly simplified.

Larger pumps are available with either flange or threaded inlets and outlets.





model 809-BR-HS-C



model 809-BR



model 809-BR-12

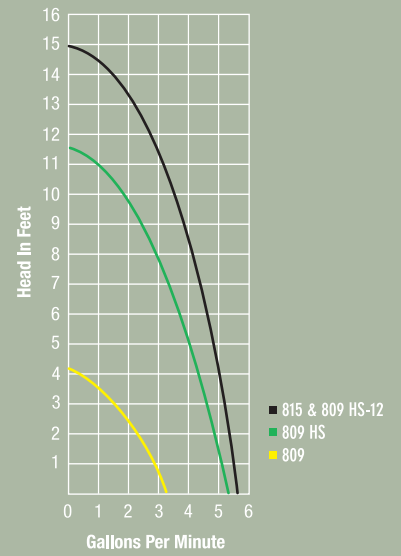

# SERIES 809 & 815

		809-BR	809-PL	809-BR-C	809-BR-12 •	809-BR-24	809-BR-HS	809-PL-HS	809-PL-HS-C	809-BR-HS-12 ◊	809-BR-HS-24	815-BR	815-BR-C
max. flow	gpm	4.5	4.5	4.5	5.5	5.5	7.2	7.2	7.2	7.5	7.5	8	8
	lpm	13.7	13.7	13.7	16.5	16.5	21	21	21	22	22	28	28
max. head	ft.	4.3	4.3	4.3	7.1	7.1	12.1	12.1	12.1	15.5	15.5	18.6	18.6
	m	.6	.6	.6	2.3	2.3	2.7	2.7	2.7	4.5	4.5	4.1	4.1
inlet (C = center inlet) ◊		1/2" MPT	1/2" MPT	C 3/4" MPT	1/2" MPT	1/2" MPT	1/2" MPT	1/2" MPT	C 3/4" MPT	1/2" MPT	1/2" MPT	1/2" MPT	C 3/4" MPT
outlet ◊		1/2" MPT	1/2" MPT	1/2" MPT	1/2" MPT	1/2" MPT	1/2" MPT	1/2" MPT	1/2" MPT	1/2" MPT	1/2" MPT	1/2" MPT	1/2" MPT
hp		1/100	1/100	1/100	1/100	1/100	1/25	1/25	1/25	1/25	1/25	1/25	1/25
kw		.007	.007	.007	.007	.007	.029	.029	.029	.029	.029	.029	.029
rpm ⊕	us	1700	1700	1700	1950	1950	3400	3400	3400	3600	3600	3400	3400
	metric	1400	1400	1400	1950	1950	2750	2750	2750	3600	3600	2750	2750
volts ⊕	us	115	115	115	12	24	115	115	115	12	24	115	115
	metric	230	230	230	12	24	230	230	230	12	24	230	230
ph		1	1	1	-	-	1	1	1	-	-	1	1
hz	us	60	60	60	DC	DC	60	60	60	DC	DC	60	60
	metric	50	50	50	DC	DC	50	50	50	DC	DC	50	50
watts	us	30	30	30	18	18	90	90	90	48	48	105	105
	metric	28	28	28	18	18	103	103	103	48	48	118	118
amp	us	.4	.4	.4	1.1	.75	1.2	1.2	1.2	3.8	1.9	1.3	1.3
	metric	.20	.20	.20	1.1	.75	.69	.69	.69	3.8	1.9	.75	.75
motor type		AC	AC	AC	AC	AC	AC	AC	AC	AC	AC	AC	AC
electrical connection		Conduit Box	Conduit Box	3 ft. SJO	Terminals	Terminals	Conduit Box	Conduit Box	3 ft. SJO	Terminals	Terminals	Conduit Box	3 ft. SJO
max. int. pressure	psi	150	50	150	150	150	150	50	150	150	150	150	150
	bar	10	3.4	10	10	10	10	3.4	10	10	10	10	10
max. liquid temp.	°f	250	250	250	250	250	250	250	250	250	250	250	250
	°c	121	121	121	121	121	121	121	121	121	121	121	121
weight packed	lbs.	5	4	6	4 1/2	4 1/2	5 1/2	5	6 1/2	4 1/2	4 1/2	5 1/2	6
	kg.	2.3	1.8	2.7	2	2	2.5	2.3	3	2	2	2.5	2.7

PUMP HOUSING: BR is Bronze, PL is Polysulfide Plastic.  
316 Stainless Steel, Silicon rubber "O" ring, Rytan® and Teflon® plastic impeller.

- ◊ Flare style and solder connections available on special order.
- ⊕ Other materials and voltages available on special order.
- ⊕ RPM at wide open flow and 0 head, RPM increases as head is increased.
- Brush life is a minimum of 10,000 hours.
- ◊ Brush life is a minimum of 7,500 hours.

Center inlet housing for 809 series can be supplied in stainless steel.



model 830-F  
with D.C. motor



model 830-BR-T

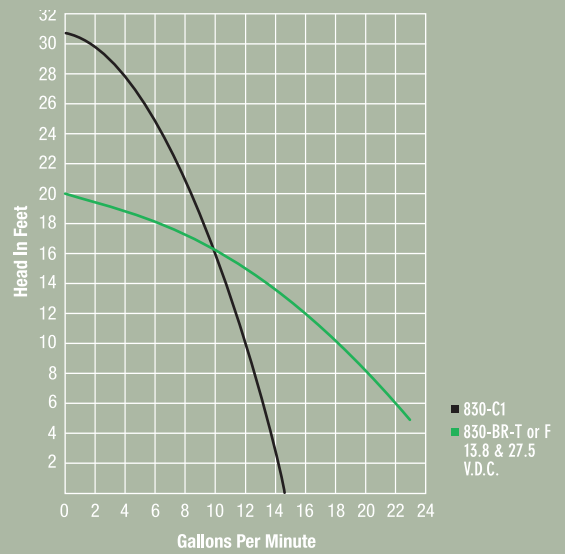

# SERIES 869 & 830

## ELECTRIC MOTORS

SERIES 869		869-CI	869-CI-T
max. flow	gpm	22	22
	lpm	63.2	63.2
max. head	ft.	8.5	8.5
	m	1.7	1.7
inlet		Flange	3/4" FPT
outlet		Flange	3/4" FPT
hp		1/20	1/20
kw		.037	.037
rpm	us	1600	1600
	metric	1600	1600
volts	us	115	115
	metric	230	230
ph		1	1
hz		50/60	50/60
watts	us	110	110
	metric	122	122
amp	us	1.8	1.8
	metric	.81	.81
motor type		BC	BC
electrical connection		Conduit Box	Conduit Box
max. int. pressure	psi	150	150
	bar	10	10
max. liquid temp.	°f	350	350
	°c	176	176
weight packed	lbs.	13	11
	kg.	5.5	5
materials in contact with solution		Cast Iron, 304 Stainless Steel, Nylon Plastic, Carbon Bushing, Nitrile/Fibre Gasket	

## ELECTRIC MOTORS

SERIES 830		830-CI	830-CI-T	830-BR	830-BR-T	830-BR-T-12	830-BR-F-12	830-BR-T-24	830-BR-F-24
max. flow	gpm	15	15	15	15	22.5	22.5	22	22
	lpm	44	44	44	44	92	92	92	92
max. head	ft.	30.5	30.5	30.5	30.5	19.5	19.5	18	18
	m	6.5	6.5	6.5	6.5	5.8	5.8	5.8	5.8
inlet		Flange	3/4" FPT	Flange	3/4" FPT	3/4" FPT	Flange	3/4" FPT	Flange
outlet		Flange	3/4" FPT	Flange	3/4" FPT	3/4" FPT	Flange	3/4" FPT	Flange
hp		1/5	1/5	1/5	1/5	1/6	1/6	1/6	1/6
kw		.149	.149	.149	.149	.166	.166	.166	.166
rpm	us	3450	3450	3450	3450	2960	2960	2920	2920
	metric	2850	2850	2850	2850	2960	2960	2920	2920
volts	us	115	115	115	115	13.8	13.8	27.5	27.5
	metric	230	230	230	230	13.8	13.8	27.5	27.5
ph		1	1	1	1	-	-	-	-
hz		50/60	50/60	50/60	50/60	DC	DC	DC	DC
watts	us	350	350	350	350	164	164	151	151
	metric	350	350	350	350	164	164	151	151
amp	us	3.6	3.6	3.6	3.6	11.9	11.9	5.5	5.5
	metric	1.97	1.97	1.97	1.97	11.9	11.9	5.5	5.5
motor type		AC	AC	AC	AC	AC	AC	AC	AC
electrical connection		Conduit Box	Conduit Box	Conduit Box	Conduit Box	Terminals	Terminals	Terminals	Terminals
max. int. pressure	psi	150	150	150	150	150	150	150	150
	bar	10	10	10	10	10	10	10	10
max. liquid temp.	°f	250	250	250	250	250	250	250	250
	°c	121	121	121	121	121	121	121	121
weight packed	lbs.	21	18 1/2	21 1/2	19	14	14	14	14
	kg.	9.5	8	10	8.5	6.5	6.5	6.5	6.5
materials in contact with solution		Cast Iron, 304 Stainless Steel, Rytan® Plastic, Ceramic, Nitrile/Fibre Gasket, Carbon		Bronze, 304 Stainless Steel, Rytan® Plastic, Ceramic, Nitrile/Fibre Gasket, Carbon		Pump Casings: BR is Bronze, 304 Stainless Steel Rear Housing, Carbon/Rytan® Plastic Impeller, Ceramic Thrust Washer and Nitrile Fibre Gasket			





model 802



model 851



model AC-1A-MD



model AC-1A-MD / AC-2AP-MD

# DUAL HEAD PUMPS

## 3 to 8 gpm

March dual head pumps are the choice for applications requiring simultaneous pumping of two different solutions (such as in film processing equipment). A variety of construction materials ensures proper chemical compatibility for many applications.

		802	851	AC-1A-MD	AC-1A-MD	AC-2AP-MD
max. flow each head	gpm	7	8	3	3	5
	lpm	23	33.4	9	9	18
max. head	ft.	16.5	20	4.6	4.6	13
	m	3.9	4.9	1	1	2.5
inlet		1/2" OD	5/8" OD	1/2" OD	1/2" OD	1/2" OD
		1/2" OD	5/8" OD	1/2" OD	1/2" OD	1/2" OD
outlet		1/2" OD	5/8" OD	1/2" OD	1/2" OD	1/2" OD
hp		1/8	1/8	1/175	1/25	1/25
kw		.093	.093	.004	.029	.029
rpm <sup>Ⓢ</sup>	us	3450	3450	3200	3450	3450
	metric	2850	2850	2750	2750	2750
volts <sup>Ⓢ</sup>	us	230	230	115	230	230
	metric	230	230	230	230	230
ph		1	1	1	1	1
hz		50/60	50/60	60	50/60	50/60
watts	us	180	140	26	93	93
	metric	126	165	25	98	98
amp	us	.84	.65	.5	.85	.85
	metric	.54	.72	.18	.68	.68
motor type		AC	AC	AC	AC	AC
electrical connection		2 ft. (6M)	3 ft. (9M)	16" (40cm)	3 ft. (6M)	3 ft. (6M)
		SJO	SJO	loose leads	SJO	SJO
max. int. pressure	psi	50	50	50	50	50
	bar	3.4	3.4	3.4	3.4	3.4
max. liquid temp.	°f	190	190	190	190	190
	°c	87	87	87	87	87
weight packed	lbs.	10 1/2	12	3 1/2	5 1/2	5 1/2
	kg.	4.5	5.5	1.5	2.5	2.5
materials in contact with solution <sup>Ⓢ</sup>		Polypropylene, Type 316 Stainless Steel, Viton <sup>®</sup> , Ceramic magnet	Polypropylene, Ceramic, Viton <sup>®</sup> , Ceramic magnet	Polypropylene, Nylon, Buna N, 316 Stainless Steel, Ceramic magnet, Chemloy <sup>®</sup> Washer	Polypropylene, Stainless Steel, Viton <sup>®</sup> , Ceramic magnet, Chemloy <sup>®</sup> Washer	Polypropylene, Ceramic, Viton <sup>®</sup>

Ⓢ Other materials and voltages available on special order.  
 Ⓢ RPM at wide open flow and 0 head, RPM increases as head is increased.





model 140-3



P A G E 3 1  
www.marchpump.com

# SERIES 140

## 12.5 gpm

Use the compact Series 140 pumps where maximum flow with minimal pressure is desired. Maximum flow is 12.5 GPM (55 LPM) and maximum head is 11.5 ft. (2.5m)

Series 140 pumps use 1/20 HP (.037 kw), 2900 rpm 115-volt air-cooled motors, and are made with a variety of materials such as glass-filled polypropylene, Buna N rubber, ceramic, Rytan®, Teflon® and Viton®.

		ELECTRIC MOTOR
<b>SERIES 140</b>		140-3
max. flow	gpm	12.5
	lpm	55
max. head	ft.	11.5
	m	2.5
inlet		1 1/8" OD
outlet		7/8" OD
hp		1/20
kw		.037
rpm	us	2900
	metric	2850
volts	us	115
	metric	230
ph		1
hz	us	60/50
	metric	50
watts	us	107
	metric	107
amp	us	1.3
	metric	1.3
motor type		AC
electrical connection		3 ft (.9M) SJT
max. int. pressure	psi	50
	bar	3.5
max. liquid temp.	°f	190
	°c	87
weight packed	lbs.	6
	kg.	3
materials in contact with solution		Glass filled polypropylene, Buna N, Ceramic magnet, Ceramic





model 320-CP-MD

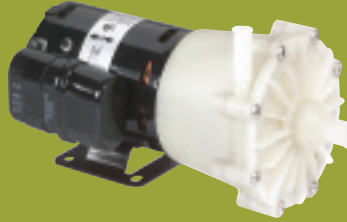

model 320-AP-MD

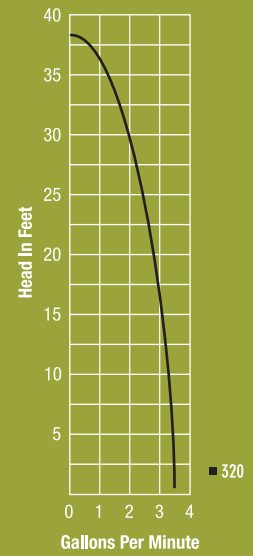

# SERIES 320 & 335

This compact, corrosion-resistant pump has the durability for continuous duty in applications requiring low flow, yet higher pressure. Typical examples include laser cooling, medical systems, filter systems and various processing equipment in the electronics industry such as computer chip processing.

## 3.3 gpm

Flow rates range from 0 to 3.3 GPM (11.3 LPM) maximum, at heads ranging from 0 to 40 ft. (8.8 m) maximum.

Series 320 pumps use a 1/12 HP (.063 kw), 3450 rpm, 115- or 230-volt single-phase, 50/60 Hz., air-cooled motor and are supplied with a 5/8" (15.9 mm) O.D. smooth inlet and a 1/2" (12.7mm) O.D. smooth outlet, or a 1/2-14 MPT inlet and a 3/8-18 MPT outlet.

## 12 gpm

Flow rates range from 0 to 12 GPM (45A LPM) maximum, at heads ranging from 0 to 68 ft. (20.7m) maximum.

Series 335 pumps use a 1/3 HP (.248 kw), 3450 rpm, 115- or 230-volt single-phase 50/60 Hz. TEFC motor. Also available with a three-phase 230- or 460-volt motor.

Housing available with 3/4 O.D. smooth inlet and outlet, or 3/4 -14 MPT inlet and outlet.

### CENTRIFUGAL PUMPS

		320-AP-MD	320-CP-MD	335-AP-MD	335-CP-MD
max. flow	gpm	3.3	3.3	12	12
	lpm	11.3	11.3	45.4	45.4
max. head	ft.	40	40	68	68
	m	8.8	8.8	20.7	20.7
inlet		5/8" OD Smooth	1/2"-14 MPT	3/4" OD Smooth	3/4"-14 MPT
outlet		1/2" OD Smooth	3/8"-18 MPT	3/4" OD Smooth	3/4"-14 MPT
hp		1/12	1/12	1/3	1/3
kw		.063	.063	.248	.248
rpm <sup>⊗</sup>	us	3450	3450	3450	3450
	metric	2850	2850	2850	2850
volts <sup>⊗</sup>	us	115	115	115/230	115/230
	metric	230	230	115/230	115/230
ph		1	1	1	1
hz		50/60	50/60	50/60	50/60
watts	us	150	150	400	400
	metric	150	150	400	400
amp	us	1.3	1.3	3.6/1.8	3.6/1.8
	metric	.65	.65	3.6/1.8	3.6/1.8
max. int. pressure	psi	50	50	50	50
	bar	3.52	3.52	3.52	3.52
max. liquid temp.	°f	190	190	190	190
	°c	88	88	88	88
weight packed	lbs.	10	10	21	21
	kg.	4.54	4.54	9.5	9.5
materials in contact with solution <sup>⊗</sup>		Glass filled polypropylene, ceramic spindle and thrust washers, Viton <sup>®</sup> O Ring		Glass filled polypropylene, ceramic spindle and thrust washers, Viton <sup>®</sup> O Ring	

⊗ Other materials and voltages available on special order.  
 ⊗ RPM at wide open flow and 0 head, RPM increases as head is increased.



model 335-AP-MD

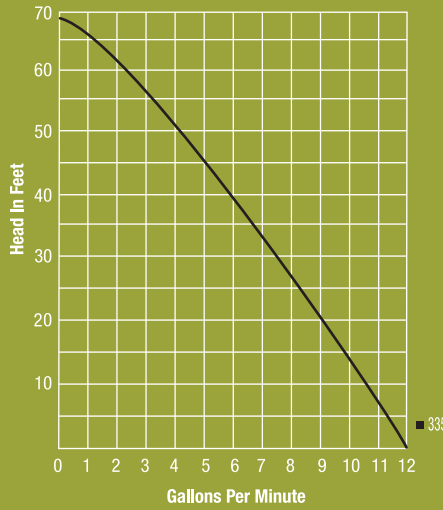

model 210-10

# METERING PUMPS

## up to 1000 cc/min

METERING PUMPS		ELECTRIC MOTORS		
		210-5	210-10	212
max. flow	cc/min	1 to 115	5 to 350	50 to 1000
max. head	ft.	160	160	60
	m	11	11	4
inlet		1/4" FPT	1/4" FPT	1/4" FPT
outlet		1/4" FPT	1/4" FPT	1/4" FPT
hp		1/50	1/50	1/50
kw		.014	.014	.014
rpm	us	75	235	235
	metric	64	187	187
volts	us	115	115	115
	metric	230	230	230
ph		1	1	1
hz	us	60	60	60
	metric	50	50	50
watts	us	50	50	50
	metric	40	40	40
amp	us	.8	.8	.8
	metric	.35	.35	.35
motor type		AC	AC	AC
electrical connection		6 ft (1.8M) SJT w/ plug	6 ft (1.8M) SJT w/ plug	6 ft (1.8M) SJT w/ plug
max. int. pressure	psi	160	160	90
	bar	11	11	6
max. liquid temp.	°f	190	190	190
	°c	87	87	87
weight packed	lbs.	5 1/2	5 1/2	5
	kg.	2.5	2.5	2.3
materials in contact with solution		Ryton®, Viton®, Teflon®, Ceramic		

March positive displacement chemical feed pumps are designed for precision metering and accurate dispensing. They are recommended for intermittent duty only.

Flow rates can be precisely regulated while the pump is running by adjusting the flow control lever and locking it in position with a thumb screw lock.

The 1/50 HP (.014 KW) air-cooled motor operates at up to 235 rpm on 115-volt, 60Hz AC systems. Both inlet and outlet are 1/4" FPT. Construction materials, which include Ryton®, Viton®, Teflon® and ceramic, ensure proper chemical compatibility for many types of solutions.



model 2C



model 2U

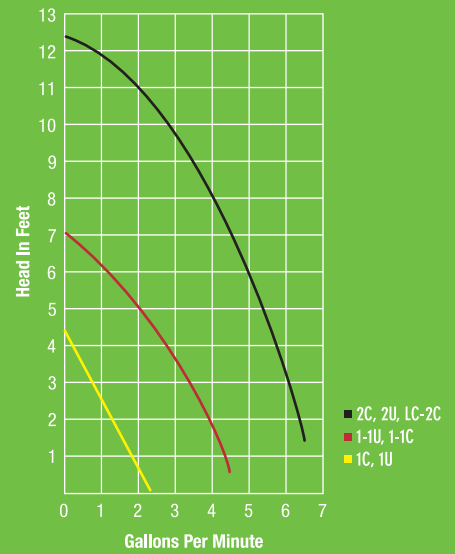

# SEAL TYPE PUMPS

Compact and inexpensive, March Seal-Type pumps can deliver a maximum flow of 6.5 GPM (18.5 LPM) and handle a maximum head of up to 12.5 ft. (2.7 M). Typical applications include advertising displays, ice flakers, icemakers and machine oiling systems. Maximum recommended fluid temperatures are 130° F (54° C).

Seal-type pumps are available in both open air and epoxy clad submersible models. Options for wetted materials include Noryl®, Delrin®, nylon, Viton®, stainless steel, cork and neoprene. A Viton® rubber spring loaded lip seal prevents the liquid from entering into the sealed motor area. Inlet options are 3/8" FPT, 3/8" MPT while outlets are 1/4" MPT.

Seal-type pumps use 1/75 or 1/35 HP (.009 to .021 Kw), 3200 rpm, 115 volt single phase, 50/60 Hz., epoxy-encapsulated submersible motors (maroon in color), suitable for both open air or submersible duty. Motors for submersible operation only are color-coded blue.

### ELECTRIC MOTORS

SEAL TYPE PUMPS		ELECTRIC MOTORS					
		1C	1U	1-1C	1-1U	2C	2U
max. flow	gpm	2.3	2.3	4.5	4.5	6.5	6.5
	lpm	8.02	8.02	12.8	12.8	18.5	18.5
max. head	ft.	4.2	4.2	7	7	12.5	12.5
	m	1	1	1.43	1.43	2.7	2.7
inlet		3/8" MPT	SCREEN	3/8" MPT	SCREEN	3/8" FPT	SCREEN
outlet		1/4" MPT	1/4" MPT	1/4" FPT	1/4" MPT	1/4" MPT	1/4" MPT
hp		1/75	1/75	1/75	1/75	1/35	1/35
kw		.009	.009	.009	.009	.021	.021
rpm	us	3200	3200	3200	3200	3200	3200
	metric	2750	2750	2750	2750	2750	2750
volts	us	115	115	115	115	115	115
	metric	230	230	230	230	230	230
ph		1	1	1	1	1	1
hz	us	60	60	60	60	60	60
	metric	50	50	50	50	50	50
watts	us	40	40	40	40	67	67
	metric	31	31	34	34	53	53
amp	us	.75	.75	.75	.75	1.2	1.2
	metric	.28	.28	.29	.29	.43	.43
motor type		TE/SUB	SUB	TE/SUB	SUB	SUB	SUB
electrical connection		6 ft (1.8M) SJT w/ plug	6 ft (1.8M) SJT w/ plug	6 ft (1.8M) SJT w/ plug	6 ft (1.8M) SJT w/ plug	6 ft (1.8M) SJT w/ plug	6 ft (1.8M) SJT w/ plug
max. int. pressure	psi	20	20	20	20	20	20
	bar	1.3	1.3	1.3	1.3	1.3	1.3
max. liquid temp.	°f	130	130	130	130	130	130
	°c	54	54	54	54	54	54
weight packed	lbs.	3	3	3	3	4	4
	kg.	1.4	1.4	1.4	1.4	1.8	1.8
materials in contact with solution		Nylon, Stainless Steel, Viton®, Cork & Neoprene Gaskets, Aluminum bracket	Nylon, Delrin®, Noryl®, Stainless Steel, Viton®, Cork & Neoprene	Nylon, Stainless Steel, Viton®, Cork & Neoprene Gaskets, Aluminum bracket	Nylon, Delrin®, Noryl®, Stainless Steel, Viton®, Cork & Neoprene	Nylon, Stainless Steel, Viton®, Cork & Neoprene Gaskets, Aluminum bracket	Nylon, Delrin®, Noryl®, Stainless Steel, Viton®, Cork & Neoprene

## Pump Directory

Pump		page no.
SERIES 1	1.7 to 3.0 gpm	6
SERIES 893	2.7 to 3.0 gpm	8
SERIES MDX	5.5 to 8.4 gpm	10
SERIES 2	5.5 gpm	12
SERIES 3	10 gpm	14
SERIES 4	14 gpm	16
SERIES 5	18 gpm	18
SERIES 5.5	30 gpm	20
SERIES 6	38 gpm	21
SERIES 7	53 gpm	22
SERIES 7.5	82 gpm	24
SERIES 8	125 gpm	25
SERIES 10	210 gpm	26
HYDRONIC PUMPS	4.5 to 22 gpm	27
SERIES 809 & 815		28
SERIES 869 & 830		29
DUAL HEAD	3 to 8 gpm	30
SERIES 140	12.5 gpm	31
SERIES 320 & 335	3.3 gpm	32
METERING PUMPS	1 to 1000 cc / min	33
SEAL TYPE PUMPS	2.3 to 6.5 gpm	34

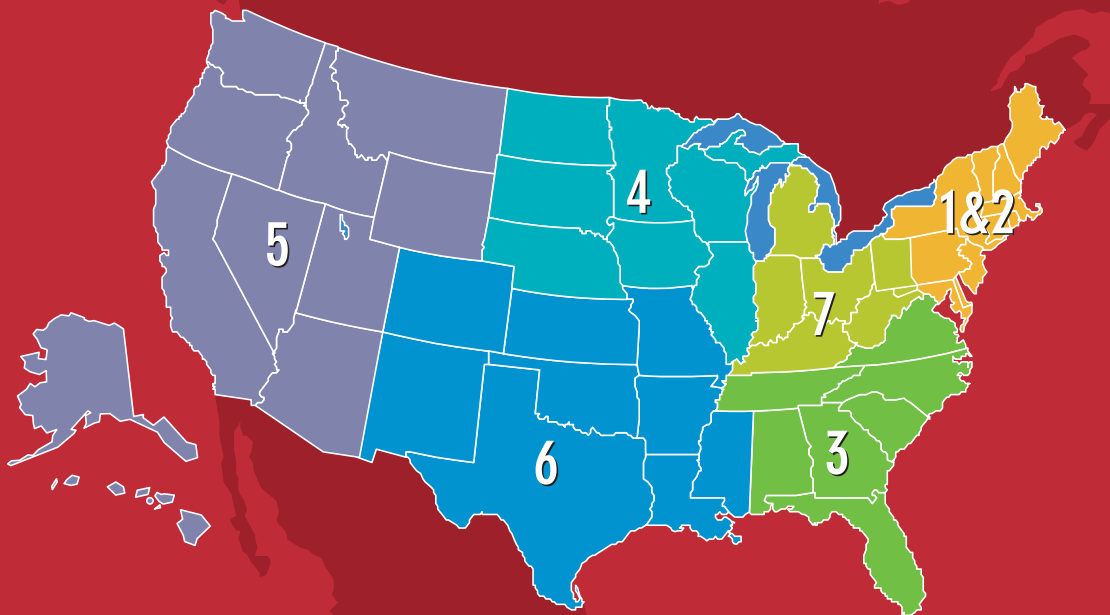

March Manufacturing has 7 sales offices to serve you in the U.S.A. and Canada.  
 For more information, contact our corporate office at 847-729-5300  
 or visit our website at [www.marchpump.com](http://www.marchpump.com)

## MARCH INTERNATIONAL DISTRIBUTORS

### March Pumpen Gmbh

Raiffeisnstr.8  
 D-61191 Rosbach v.d.h.  
 Germany  
 phone: 49-6003-82860  
 fax: 49-6003-828660  
[www.march-pumpen.com](http://www.march-pumpen.com)

Germany, France, Holland, Belgium,  
 Denmark, Spain, Luxembourg,  
 Portugal, Italy, Greece, Austria,  
 Switzerland, Sweden, Norway,  
 Finland, Poland, Yugoslavia, Romania,  
 Hungary, Czechoslovakia, Bulgaria,  
 Albania, Russia.

### March May Ltd.

Eaton Works, Howard Road  
 Eaton Socon, St. Neots  
 Cambridgeshire, England  
 PE198NZ  
 phone: 1480.214444  
 fax: 1480.405336  
[www.marchmay.co.uk](http://www.marchmay.co.uk)

Great Britain, Northern Ireland, Ireland

### Dorian Drake International

2 Gannett Drive  
 White Plains, NY 10604  
 phone: 914.697.9800  
 fax: 914.698.9658 or  
 914.697.9024  
[www.doriandrake.com](http://www.doriandrake.com)

Worldwide except for United States,  
 Puerto Rico, Canada and the areas covered  
 by March May Ltd. and March Pumpen